

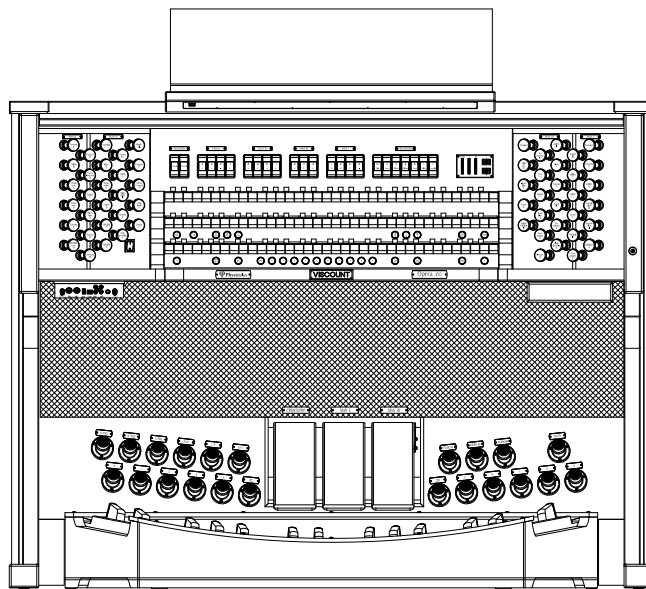

VISCOUNT

Φ Physisplus

organ series



Reference Manual - English

Edition: 1.0

IMPORTANT SAFETY INSTRUCTIONS

WARNING: READ THIS FIRST!

AVIS IMPORTANT!



This symbol is intended to alert the user to the presence of uninsulated "dangerous voltage" within the product's enclosure that may be of sufficient magnitude to constitute a risk of electric shock to persons.

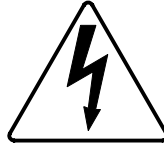

Ce symbole sert pour avertir l'utilisateur qu'à l'intérieur de ce produit sont présents éléments non isolés soumis à "tensions dangereuses" suffisants à créer un risque d'électrocution.

This symbol is intended to alert the user to the presence of important operating and maintenance (servicing) instructions in the literature accompanying the appliance.



Ce symbole sert pour avertir l'utilisateur qu'à l'intérieur de la documentation de l'appareil sont présentes importantes instructions pour l'utilisation correcte et la manutention de l'appareil.

WARNING
TO REDUCE THE RISK OF FIRE OR ELECTRIC SHOCK:
DO NOT EXPOSE THIS APPARATUS TO RAIN OR MOISTURE
AND OBJECTS FILLED WITH LIQUIDS, SUCH AS VASES,
SHOULD NOT BE PLACED ON THIS APPARATUS.
DO NOT REMOVE COVER (OR BACK)
NO USER-SERVICEABLE PARTS INSIDE
REFER SERVICING TO QUALIFIED SERVICE PERSONNEL

ATTENTION
AFIN D'ÉVITER LES RISQUES DE FEU OU SCHOCK ÉLECTRIQUE:
N'EXPOSEZ PAS CET INSTRUMENT À PLUIE OU HUMIDITÉ
NE PAS OUVRIR LE COUVERCLE (OU PANNEAU ARRIÈRE)
L'UTILISATEUR NE PEUT EFFECTUER AUCUNE RÉPARATION
POUR TOUTE RÉPARATION ÉVENTUELLE, FAIRE APPEL À
UN PERSONNEL QUALIFIÉ

"INSTRUCTIONS PERTAINING TO A RISK OF FIRE, ELECTRIC SHOCK, OR INJURY TO PERSONS"

WARNING:

- 1) Read these instructions.
- 2) Keep these instructions.
- 3) Heed all warnings.
- 4) Follow all instructions.
- 5) Do not use this apparatus near water.
- 6) Clean only with dry cloth.
- 7) Do not block any ventilation openings. Install in accordance with the manufacturer's instructions.
- 8) Do not install near any heat sources such as radiators, heat registers, stoves, or other apparatus (including amplifiers) that produce heat.
- 9) Do not defeat the safety purpose of the polarized or grounding-type plug. A polarized plug has two blades with one wider than the other. A grounding type plug has two blades and a third grounding prong. The wider blade or the third prong are provided for your safety. If the provided plug does not fit into your outlet, consult an electrician for replacement of the obsolete outlet.
- 10) Protect the power cord from being walked on or pinched, particularly at plugs, convenience receptacles, and the point where they exit from the apparatus.
- 11) Only use attachments/accessories specified by the manufacturer.
- 12) Use only with the cart, stand, tripod, bracket, or table specified by the manufacturer, or sold with the apparatus.
When a cart is used, use caution when moving the cart/apparatus combination to avoid injury from tip-over.
- 13) Unplug this apparatus during lightning storms or when unused for long periods of time.
- 14) Refer all servicing to qualified service personnel. Servicing is required when the apparatus has been damaged in any way, such as power-supply cord or plug is damaged, liquid has been spilled or objects have fallen into the apparatus, the apparatus has been exposed to rain or moisture, does not operate normally, or has been dropped.



NOTE: The socket-outlet shall be installed near the equipment and shall be easily accessible. To completely disconnect this apparatus from the AC MAINS, disconnect the power supply cord plug from the AC receptacle.

SAVE THESE INSTRUCTIONS

INSTRUCTIONS À CONSERVER

TABLE OF CONTENTS

| | |
|--|-----------|
| Important notes | 3 |
| Product Care..... | 3 |
| Notes about this manual..... | 3 |
| General descriptions | 4 |
| Switching on and main video page | 9 |
| How to navigate in the menus | 9 |
| The Main Menu..... | 10 |
| The Pipe Sets | 11 |
| What a Pipe Set contains | 11 |
| The Pipe Set menu | 11 |
| Selection of a Pipe Set (Select function) | 12 |
| Copy or rename of a Pipe Set (Copy/Rename function) | 12 |
| Restore the original content of a Pipe Set (Restore Default function)..... | 12 |
| The Combinations Sets | 13 |
| The Combinations menu | 13 |
| Selection of a Combinations Set (Select function) | 14 |
| Copy or rename of a Combinations Set (Copy/Rename function) | 14 |
| Deleting the contents of a Combinations Set (Clear function) | 14 |
| Insert a protection code (PIN) for a Combinations Set (Set Pin function) | 14 |
| Saving a Combinations Set in a USB flash drive (Export function)..... | 15 |
| Loading a Combinations Set from a USB flash drive (Import function)..... | 15 |
| Reset the Main Combinations Set (Reset Main Cmb function)..... | 15 |
| Setting the volumes (Levels menu)..... | 16 |
| Tuning the instrument (Tuning menu) | 17 |
| Programming Custom temperament | 17 |
| Adjusting the tremulants/tremolos (Tremulants/Tremolos function)..... | 18 |
| Fine adjustment of the AIR PRESSURE parameter (Air Supply Config function)..... | 18 |
| Selecting and regulating the voices (Voicing menu) | 20 |
| Explanation of the Int. Chest (Internal Windchest parameter) | 21 |
| Selecting and adjusting the orchestral voices | 24 |
| Saving different orchestra voices and parameters in the combinations..... | 24 |
| Keyboards settings (Setup / Keyboards menu)..... | 26 |
| Setting the keyboards / pedalboard velocity (Velocity function)..... | 26 |
| Adding the keyboards / pedalboard keys mechanical noises (Keyboards Noise function)..... | 27 |
| Configuring of the Keyboards Inversion function (Inversion function)..... | 27 |
| Enabling of the Short Octave (1st Short Octave function) | 28 |
| Synchronizing of the divisional combinations (Piston Combine function) | 28 |
| Configuring of the Organ Solo function (Organ Solo function)..... | 29 |
| Setting the Automatic Pedal mode (A.P. Mode parameter) | 29 |
| Organ controls settings (Setup / Controls menu) | 30 |
| Combinations settings (Setup / Combinations menu)..... | 31 |

| | |
|---|-----------|
| Audio settings (Setup / Audio menu) | 33 |
| Adjusting the internal Reverb effect (Reverberation function)..... | 33 |
| Setting the internal amp equalizer (Int. Amp Equalizer function)..... | 34 |
| Adjusting the front and side speakers (Surround Sound function)..... | 34 |
| Regulating the volume of the PROG. OUT rear outputs (Ext. Out Volumes function)..... | 35 |
| Routing of the audio inputs to the outputs (Input To Output function)..... | 35 |
| MIDI settings (Setup / MIDI menu) | 36 |
| Selecting the input and output channels (Tx/Rx Channels function)..... | 36 |
| Setting the input and output filters (MIDI Filters function)..... | 37 |
| Saving Program Change messages in the combinations (Prg In Combin. function)..... | 37 |
| Backup, restore and factory reset of organ configuration (Backup/Restore menu) | 38 |
| What a Snapshot contains..... | 38 |
| Save the organ configuration in a USB flash drive (Save Snapshot function)..... | 39 |
| Load an organ configuration from a USB flash drive (Load Snapshot function)..... | 39 |
| Restore the factory organ configuration (Factory Reset function)..... | 40 |
| Restore the default settings (Restore Def. Setting function)..... | 40 |
| Utilities functions (Utility menu) | 41 |
| Upgrading the operating system (Op. Sys. Upgrade function)..... | 41 |
| Controlling the access to the organ settings (Lock Organ function)..... | 42 |
| Pedals calibration (Shoes Calibration function)..... | 43 |
| Playing and recording of musical sequences (Sequencer) | 44 |
| Playing back a song or a song list (Play mode)..... | 44 |
| Recording a song (Record mode)..... | 45 |
| Overdubbing a song (Overdub mode)..... | 46 |
| Creating lists of songs (Song List function)..... | 47 |
| Play options of the sequencer (Play Options menu)..... | 48 |
| Appendix | 49 |
| Stop Local Off..... | 49 |
| On-screen error and info messages..... | 49 |
| Temperament..... | 50 |
| Temperaments of the Physis Plus organs..... | 52 |
| The windchest in pipe organs..... | 57 |
| What MIDI is..... | 58 |
| Detailed MIDI Implementation..... | 60 |

IMPORTANT NOTES

Product Care

- Do not apply excessive force to the instrument's structures and controls (knobs, buttons, keyboard etc...).
- Whenever possible, do not place the instrument close to units that generate strong interference, such as radio - TV sets, monitors, etc ...
- Do not place the instrument close to heat sources, in damp or dusty places or in the vicinity of strong magnetic fields.
- Do not expose the instrument to direct sunlight.
- Never insert foreign bodies or liquids of any kind into the instrument.
- For cleaning use only a soft brush or compressed air; never use detergents, solvents or alcohol.
- Always use good quality screened cables for connection to amplification or diffusion systems. When disconnecting cables from sockets, always take hold of the connector and not the cable itself; when winding cables do not knot or twist them.
- Before making connections make sure that the other units you are about to connect (especially amplification and diffusion systems) are switched off. This will prevent noisy or even dangerous signal peaks.
- Connect the net cable to an earthed socket.
- Check that the voltage corresponds to the voltage shown on the serial number plate of the organ.
- If the instrument is to be out of use for long periods, disconnect the power cable from the power socket.
- Do not place the power cord near heat sources. Do not bend the cable too much, or damage it.

Notes about this manual

- Keep this manual with care.
- This manual is an integral part of the instrument. The descriptions and illustrations contained in this publication are not binding.
- While the instrument's essential characteristics remain the same, the manufacturer reserves the right to make any modifications to parts, details or accessories considered appropriate to improve the product or for requirements of a constructional or commercial nature, at any time and without undertaking to update this publication immediately.
- All rights reserved; the reproduction of any part of this manual, in any form, without the manufacturer's specific written permission, is forbidden.
- All the trademarks referred to in this manual are the property of the respective manufacturers.
- Please read all the information carefully, so that you obtain the best performance and will from your instrument.
- The codes or numbers in square brackets ([]) indicate the names of the buttons, sliders, trimmers and connectors on the instrument. For example, [EXIT] refers to the EXIT button.
- The illustrations are purely for information purposes and may differ from your product.
- The instructions provided in this manual only concern the instrument's operating system version that was up to date when the document was released. Therefore, such instructions might not describe faithfully your current operating system release. Please, visit the website www.viscountinstruments.com to check for the newest operating system release and manual.

!!! IMPORTANT NOTE !!!

All the controls and functions available in the Physis Plus organ models are described below. Depending on the model, some of the controls may not be present.

This Reference Manual is updated to version 1.1.0 of the instrument's operating system.



Visit the Physis Plus page on our web site for the detailed description of the Physis Plus technology!

GENERAL DESCRIPTIONS

IMPORTANT NOTE
 Below are four examples of Physis Plus consoles to illustrate where the controls are typically positioned. Your organ may not look the same as one of these illustrated. Look for the one most similar to your organ to locate the controls on the instrument and find the descriptions on the next pages.

3-manuals drawknobs model
with general combinations only

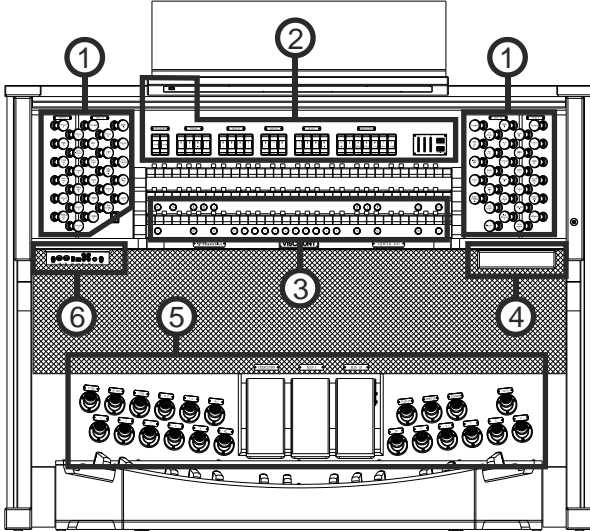

3-manuals tabs model
with general and divisional combinations

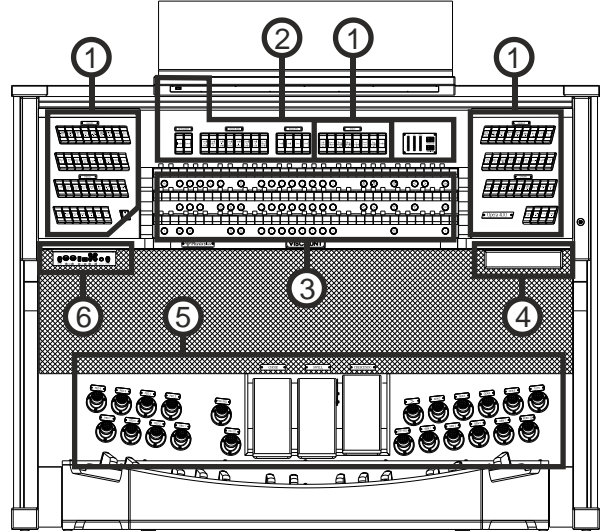

3-manuals positiv model

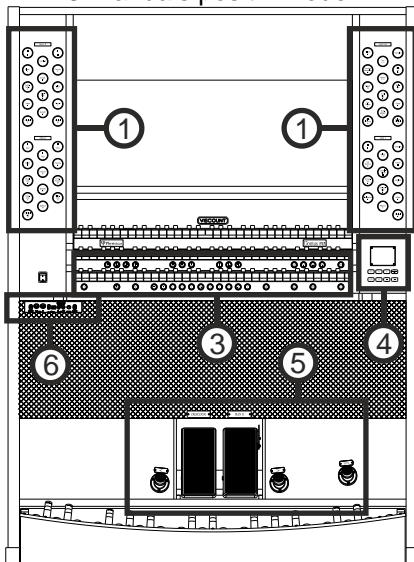

2-manuals tabs model

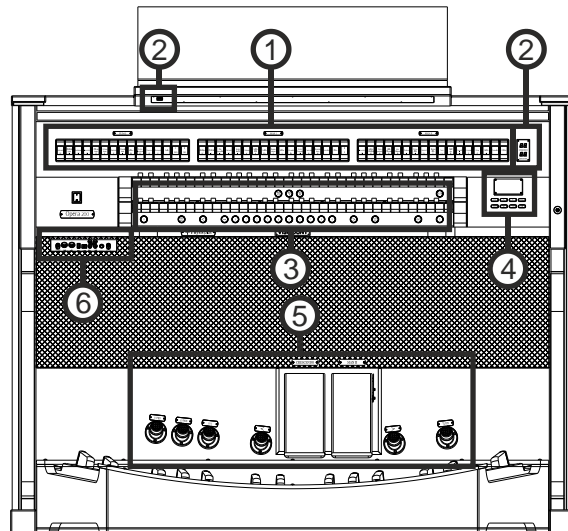

1. Stops

- **PEDAL section:** contains pedal stops and manual-pedal couplers.
- **MAN II or GREAT section:** contains stops, couplers and tremulant of Manual II or Great.
- **MAN III or SWELL section:** contains stops, coupler and tremulant of Manual III or Swell.
- **MAN IV or SOLO section:** contains stops and tremulant of Manual IV or Solo.
- **MAN I or CHOIR section:** contains stops coupler and tremulant of Manual I or Choir.

For each stop a different voice can be selected. You can also adjust the main sound-generation parameters. Further information can be found on page 20.

Two tremulants are available for each section, and both can be activated through the [TREMULANT] or [TREM] controls, depending on the model. For each tremulant it is possible to adjust speed, depth, amplitude and

waveform and assign it to each voice. Further information can be found on page 18.

It is also possible to play one or two orchestral voices in each section. In some models, in which orchestral stops are not present, it's necessary to activate the orchestral voice through the functions described on page 24. The list of stops available to play orchestral voices may change, according to the sound configuration of the organ. Check the web site www.viscountinstruments.com for further information.

For some models, these sections also contain a [MIDI] control, to transmit MIDI-note codes to the MIDI [OUT] port.

2. Upper panel

- **Light switch:** on-off button for the music stand and manuals lights.
- **SPEAKERS section:** amplification controls.
 - **[CONSOLE]:** switches on/off the instrument's internal amplification system.
 - **[EXTERNAL]:** this command activates the PROG.OUT outputs in the rear panel (page 8), in order to link external speakers to the instrument and use them to diffuse the sound around the ambience.
- **PEDAL section:** couplers, sub and super octave of the pedalboard.
- **MAN II or GREAT section:** couplers, sub and super octave of the Manual II or Great.
- **MAN III or SWELL section:** couplers, sub and super octave of the Manual III or Swell.
- **MAN I or CHOIR section:** couplers, sub and super octave of the Manual I or Choir.
- **COUPLERS section:** couplers, sub and super octave of the manuals and pedalboard.
- **SOLO TO section:** couplers of Solo section to the other manuals and pedalboard.
- **MIDI section:** these controls, provided for each manual and the pedalboard, allow transmission of the note MIDI messages on the MIDI [OUT] port to be enabled and disabled. All the instrument's other MIDI messages will continue to be transmitted, even with the MIDI control is off.
- **TREMULANTS or TREMOLO section:** here are the tremulants of each section. Further information are available in *STOPS*.
- **ORCHESTRA section:** contains the orchestral voices. It is possible to select the voice activated by the stop and adjust the main sound generation parameters of each voice. For further information see page 24.
- **Additional displays.**
 - **[CRESC] or [CRESCENDO]:** shows the step currently reached by the [CRESCENDO] pedal.
 - **[I] or [CH]:** Manual I or Choir expression level regulated by the [MAN. I] or [CHOIR] expression pedal.
 - **[II]:** Manual II expression level regulated by the [MAN II] expression pedal.
 - **[III] or [SW]:** Manual III or Swell expression level regulated by the [MAN III] or [SWELL] expression pedal.
 - **[TRANSPOSER]:** the transposition set by the TRANSPOSER parameter (page 17).
 - **[MEM. BANK]:** displays the memory bank of the combinations, selected using the [- -] or [MEM BANK +] and [MEM BANK -] thumb pistons.

3. Thumb pistons

- **General combinations.**
 - **[- -]:** press this thumb piston and then the [0] / [9] pistons to select the desired memory bank and general combination. The first two presses of [0] / [9] piston select the memory bank, the third press selects the combination. For example, pressing pistons [2], [0] and [4] selects the combination 4 of the memory bank 20.
 - **[HR]:** restores the voice setup prepared in manual mode before a memory was recalled.
 - **[0] / [9] or [1] / [8] / [10] / [12]:** pistons to recall the combinations saved in the selected memory bank. These combinations can be modified. To do so, follow the procedure described for [S] or [SET] thumb piston.
 - **[<] / [>] or [PREV] / [NEXT]:** general combinations sequencers. [<] or [PREV] selects them in descending order, [>] or [NEXT] in ascending order.
- **Divisional combinations.**

[1] / [6] / [8]: under each manual there are thumb pistons for recalling the divisional combinations. The Pedal ones can be under the Manual I or Choir (on the left) or as toe pistons. These combinations can be modified. To do so, follow the procedure described for [S] or [SET] thumb piston.

NOTES

- *When the organ is switched on, memory bank 0 (in the models equipped with the [- -] thumb piston) or 1 is always selected.*
- *Combinations Sets are available in the Physis Plus organs thanks to which the number of usable combinations is extended. For more information see page 13.*

- **[TUTTI]:** thumb piston that recalls Tutti. The Tutti can be modified. To do so, follow the procedure described for [S] or [SET] thumb piston.
- **[PLENUM]:** Plenum thumb piston whose content is added to the stop configuration prepared by hand or by combination. The Plenum can be modified. To do so, follow the procedure described for [S] or [SET] thumb piston.
- **[S] or [SET]:** piston to save general or divisional combinations, Tutti, Plenum and Crescendo steps.
To save a combination in the actual memory bank:
 - 1) Press and hold the [S] or [SET] thumb piston.
 - 2) Press the desired combination thumb or toe piston.
 - 3) Release the [S] or [SET] thumb piston.

To save a combination in another memory bank,

- *In the organ models equipped with [- -] thumb piston:*
 - 1) Select the memory bank pressing [- -] then press two [0] / [9] pistons.
 - 2) Press and hold [S] or [SET].
 - 3) Press [0] / [9] piston to select the combination to be saved.
For example, pressing pistons [2], [0] and [4] saves the combination 4 of the memory bank 20.
 - 4) Release the [S] or [SET] thumb piston.
- *In the organ models equipped with MEM BANK thumb pistons:*
 - 1) Press [MEM BANK +] or [MEM BANK -] to select the memory bank
 - 2) Press and hold [S] or [SET].
 - 3) Press the thumb piston of general or divisional combination you have to save.
 - 4) Release the [S] or [SET] thumb piston.

To save Tutti or Plenum:

- 1) Press and hold the [S] or [SET] thumb piston.
- 2) Press the [TUTTI] or [PLENUM] thumb or toe piston
- 3) Release the [S] or [SET] thumb piston.

To save a Crescendo step:

- 1) Select it through the [CRESCENDO] pedal.
- 2) Press and hold the [S] or [SET] thumb piston.
- 3) Press the [HR] or [ENC] (where [HR] is not present) thumb piston.
- 4) Release the [S] or [SET] thumb piston.

To copy the content of one Crescendo step to another:

- 1) Select the step you wish to copy.
- 2) Press and hold the [S] or [SET] thumb piston.
- 3) Select the step in which you wish to paste the content.
- 4) Press the [HR] or [ENC] (where [HR] is not present) thumb piston.
- 5) Release the [S] or [SET] thumb piston.

- **[PIPE SET]:** this thumb piston allows you to select the desired Pipe Set. To do this press this piston and within 5 seconds one of the general combination lit pistons
In the organ models not equipped with this thumb piston, to select a Pipe Set follow the procedure described at page 12.
- **ORCH thumb pistons:** orchestral voices pistons of each organ section.
- **Coupler thumb pistons:** under each manual there are the thumb pistons to enable and disable the couplers to the other manuals and/or pedalboard.
- **MIDI thumb pistons:** thumb pistons that provided, for each manual and the pedalboard, allow transmission of the note MIDI codes on the MIDI [OUT] port to be enabled and disabled. All the instrument's other MIDI messages will continue to be transmitted, even with the MIDI control is off.
- **[ORGAN SOLO] or [ORG SOLO]:** activates the Organ Solo function. By default, using this function you can play the melody with Swell stops when the III/II or II/I or Swell/Great (depending on the organ model) coupling is active. Therefore, all the while the function is active, the highest notes are played with monophonic Swell voices. However the function can be customized among the ORGAN SOLO function in the KEYBOARDS menu (page 29).
- **[AUTO PED] or [AUTO PEDAL]:** activates the Automatic Pedal or the Pedal Automatic Piano function. Select the mode of the piston among the A.P. MODE parameter in the KEYBOARDS menu (page 29).
- **[ENC] or [SWS]:** when the Enclosed or All Swells in Swell function is active, the main volume can be controlled through the [MAN.III] or [MAN.II] or [SWELL] (depending on the organ model) expression pedal. Which expression pedal and which section are controlled can be customized among the ENC or SWS CONFIG function in the CONTROLS menu (page 30).
- **[C] or [CAN]:** Cancel thumb piston to turn off all stops, tremulants, couplers, and the other pistons on the manuals (except when differently set through the functions in the CONTROLS menu, see page 30).

- **[CYMB STRN] or [ZIMB]:** switches on and off the Zimbelstern sound.
- **[MAN TRANS]:** Manuals Transfer thumb piston. By default, using this thumb piston it is possible to invert the Manual II or Great with Manual I or Choir. However the function can be customized among the INVERSION function in the KEYBOARDS menu (page 27).
- **[REED 32]:** switches on and off the reed 32' pedalboard's stops.
- **[DIAP 32]:** switches on and off the diapason 32' pedalboard's stops.
- **[MAIN ON]:** switches on and off the Main audio outputs. The configuration of the external audio outputs is available in the "Physis Plus The Editor" application.
- **[ANT ON]:** switches on and off the Antiphonal audio outputs. The configuration of the external audio outputs is available in the "Physis Plus The Editor" application.
- **[P / D]:** Pipe / Digital thumb piston which allows to play voices with the internal sound generation or with organ pipes through systems of external interfacing as Viscount VPI.

To the left of the manuals there is the Power switch to switch on/off the instrument.
In the models with roll top, to the right of the manuals there is the roll top lock.

4. Control and programming section

The buttons and the display in this section allow the user to program and set up the instrument and use the internal sequencer. Depending on the model, this section is located in a drawer on the right underneath the manuals, or in the upper panel, or on the right of the manuals. The buttons to visualize and navigate through all the display screens are located near the display and are:

- **[SONG]:** access the video pages of the internal sequencer.
- **[LEVELS]:** access the video page for all the volume settings available in the instruments.
- **[^] and [v]:** buttons used to move the cursor, identified by the field in reverse. [^] moves it in the field above or the previous field, [v] in the field below or the next field.
- **[+] and [-]:** buttons which regulate the values of the parameters, whether they are numerical or alphanumerical. [+] increases, [-] decreases.
- **[EXIT] and [MENU/ENTER]:** access and quit the display screens and menus, or confirm or cancel prompts made by the system. [MENU/ENTER] accesses menus/screens and confirms, [EXIT] quits menus/screens and cancels. If it is held pressed for a while, the main screen is immediately displayed, regardless of the current menu level

5. Expression pedals and toe pistons

- **[CRESCENDO] pedal:** with this pedal you can select the Crescendo level (step). These levels activate a fixed set of stops, linked with an equal number of loudness, from *pianissimo* to *fortissimo*. The current level is shown on the [CRESCENDO] or [CRESC] additional display (see point 2) and in the display by the CRESC. field in the main video page (see page 9). The Crescendo controls all the registers and couplers. Each level of the Crescendo can be programmed. To save the Crescendo configuration, see [S] or [SET] thumb piston description.
- **Expression pedals:** the expression pedals control at every time the volume of one or more sections, and can be used to obtain the most diverse dynamic effects. The number of the pedals depends on the model and its number of manuals:
 - **[MAN IV] or [SOLO]:** continuous control of Manual IV or Solo volume.
 - **[MAN III] or [SWELL]:** continuous control of Manual III or Swell volume.
 - **[MAN II]:** continuous control of Manual II volume.
 - **[MAN I] or [CHOIR]:** continuous control of Manual I or Choir volume.

One of the pedals is equipped with a leverage system and can be used to control the sustain effect for Orchestral voices.

- **Couplers toe pistons:** same function of the couplers thumb pistons.
- **[0]...[9], or [GEN 1]...[GEN 12]:** same function of the general combinations thumb pistons.
- **[<] / [>] or [PREV] / [NEXT]:** same function of the general combinations sequencers thumb pistons.
- **[PED 1]...[PED 12]:** same function of the Pedal divisional combinations thumb pistons.
- **[REED 32]:** switches on and off the reed 32' pedalboard's stops.
- **[FLUE 32]:** switches on and off the flute 32' pedalboard's stops.
- **[BOMB 32]:** switches on and off the Bombarde 32' pedalboard's stop.
- **[BOURD 32]:** switches on and off the Bourdon 32' pedalboard's stop.
- **[PLENUM]:** same function of the [PLENUM] thumb piston.
- **[TUTTI]:** same function of the [TUTTI] thumb piston.
- **[ZIMBEL]:** switches on and off the Zimbelstern sound.

6. Forward connection panel

Underneath the manuals, on the left, there is a panel where you can find the most frequently used connections and controls.

- **[MASTER VOLUME]:** regulates the main volume.
- **MIDI [IN]:** MIDI input port.
- **MIDI [OUT]:** MIDI output port.
- **[USB]:** two USB ports. The right port links the organ to a computer, in order to use the “Physis Plus The Editor” Windows / Mac OS / iOS application. The left port is dedicated to USB flash drive (not included with the organ) to save and load configuration files and songs recorded using the internal sequencer.
- **AUX [IN]:** RCA line inputs which allow other instruments to be played using the organ’s internal and external amplification.
- **AUX [OUT]:** RCA line outputs with non-amplified signal, for connecting optional amplified speakers, remote amplification systems or recording systems.
- **[PHONES]:** plug for a headphone set.
- **[PHONES VOLUME]:** regulates the volume of the headphone set connected to the [PHONES] plug.

NOTES

- When a headphone jack is inserted, the organ’s internal speakers are automatically muted.
- For further information about the MIDI interface, see page 58.
- For further information about the use of a USB flash drive, see page 15, 38 and 44.

Rear connections panel

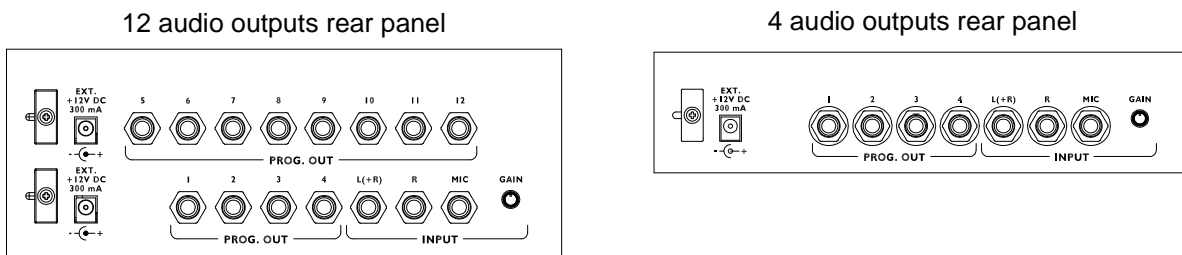

On the rear of the organ, there are various sockets to connect it to an external speaker systems, together with line and microphone input.

- **[EXT. +12V DC]:** +12 Volt can be obtained from these connectors to switch-on any VISCOUNT speaker connected to the PROG. OUT outputs.
- **PROG. OUT:** the instrument’s general line outputs, allowing simulation of the windchests of pipe organs. The signals are distributed over the outputs on the basis of the OUTPUTS settings available in the “Physis Plus The Editor” application. These settings allow you to select the type of windchest, its size based on the position in space of the speakers. Each output also has dedicated type, mode, level, equalization and reverb controls.
- **INPUT [L(+R)] / [R]:** line inputs which allow other instruments to be played using the organ’s internal and external amplification. If the source is monophonic use the [L+(R)] connector only.
- **INPUT [MIC]:** microphone input allowing amplification of the signal from a microphone.
- **[GAIN]:** trimmer for regulating the gain of the input signal received at the [MIC] connector.

WARNING!

This group of rear connections is not visible from the outside and the organ’s wooden rear panel has to be removed to access it. Contact qualified staff for this procedure.

SWITCHING ON AND MAIN VIDEO PAGE

After turning on the instrument, the display shows the Physis Plus logo video page and, once ready, the main video page:

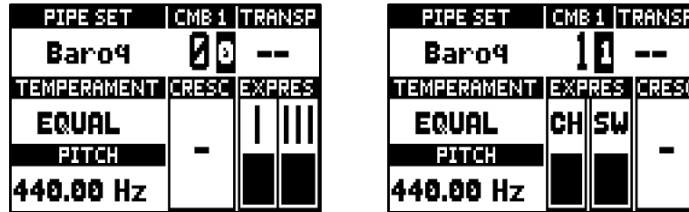

containing the following display field:

- **PIPE SET:** Pipe Set currently in use (page 11).
- **CMB:** selected combination. The first one (for memory banks from n.0 to n.9) or two (for memory banks from n.10 to n.99) numbers indicate the memory bank, the second or third number (in reverse) indicates the selected general combination as showed by the illuminated general combination thumb piston. HR is indicated by the symbol, Tutti by the symbol. The number of the selected Combinations Set is indicated next to the writing "CMB".
- **TRANSP:** transposition set in TUNING (page 17).
- **TEMPERAMENT:** temperament currently in use, selected in TUNING (page 17).
- **PITCH:** instrument's tuning, expressed as the frequency of A4, set in TUNING (page 17).
- **CRESC:** currently selected Crescendo step.
- **EXPRES:** expressions levels in according to the expression pedals position.

When the main page is displayed, [+] and [-] buttons can be used to adjust one of these parameters. To select which parameter is adjusted, use the [^] and [v] buttons, and symbols are displayed in the field of the adjusted parameter. It is also possible to regulate the reverb level or no parameter, selecting these using [^] and [v] (showed by a pop-up message).

How to navigate in the menus

Here a simple explanation how to display a specific video page, regulate a parameter and come back to the main video page. Bear in mind this procedure to reach all the parameters described in the Quick Guide and Reference Manual. Example: you have to regulate the general pitch at 439,19 Hz:

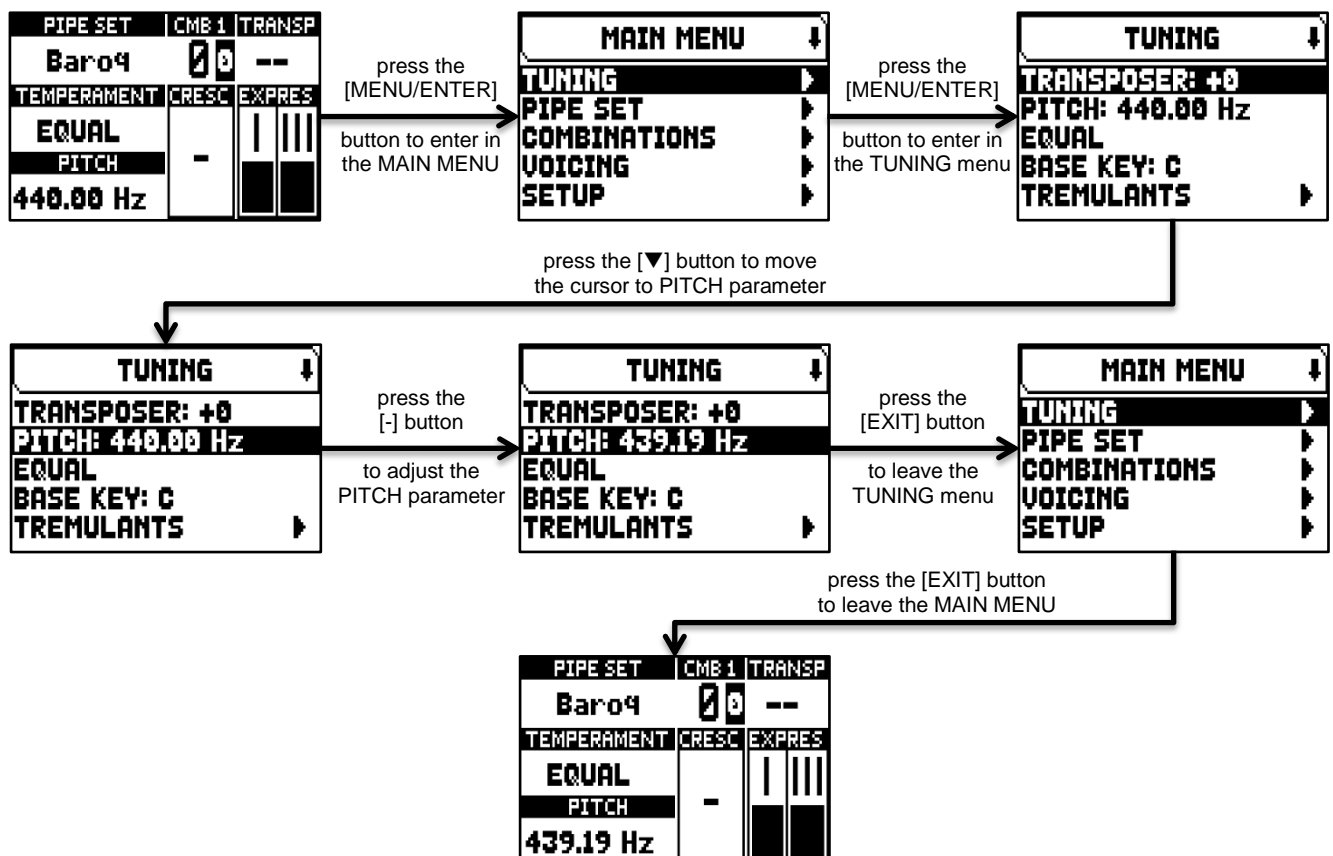

The Main Menu

The MAIN MENU gives access to all the instrument's settings.

To access to this menu, in the main video page press the [MENU/ENTER] button.

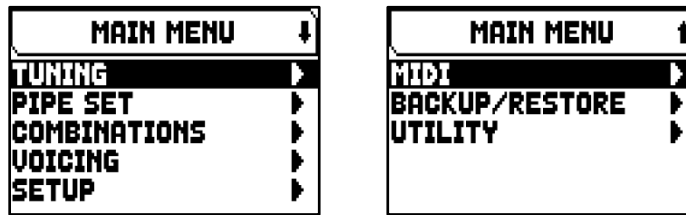

The MAIN MENU sections are the following:

| Section | Description |
|-----------------------|---|
| TUNING | Instrument's tuning parameters (see page 17). |
| PIPE SET | Selection and management of the Pipe Sets. |
| COMBINATIONS | Selection and management of the Combination Sets. |
| VOICING | Selection of alternative voices and sound generation parameters adjustment (see page 20). |
| SETUP | Instrument general settings. |
| MIDI | MIDI settings. |
| BACKUP/RESTORE | Save/Load of the entire organ configuration, reset to factory settings. |
| UTILITY | Accessory functions |

NOTE

Menus can contain two or more display pages. In this case a ↓ or ↑ symbol is displayed on the top right of the video page, indicating the presence of a next or previous page.

THE PIPE SETS

A Pipe Set identifies the entire configuration of an organ, that is the voice and the relative parameters of each stop, tuning, configuration of several controls and functions, allowing the appropriate use to the repertoire to be performed. The many Pipe Sets allow the musician to use several organ configurations, as if several different instruments were present at the same time in the same place.

The number of Pipe Sets available in the instrument depends on the organ model purchased:

- Opera models: 10 Pipe Sets of which 5 supplied by Viscount
- Maestro models: 8 Pipe Sets of which 4 supplied by Viscount
- Domus models: 6 Pipe Sets of which 3 supplied by Viscount

The Pipe Sets supplied by Viscount are already present in the instrument at the time of purchase and programmed by our laboratories on the basis of the appropriate organ schools, however it can be modified by the user.

The remaining Pipe Sets are free locations, starting from an already existing Pipe Set it is possible to copy it in a free location (but also overwrite an already existing Pipe Set) and modify each parameter and function to create a completely different Pipe Set based on the needs and musician's preferences.

What a Pipe Set contains

Below is the complete list of what a Pipe Set sets on the instrument:

| Parameter | Display page | Explanation page |
|---------------------------------------|--|------------------|
| Stop Voice | VOICING | 20 |
| Voice parameters | VOICING + extra parameters available in the "Physis Plus The Editor" application | 20 |
| Divisional volumes | LEVELS | 16 |
| Orchestra volume | LEVELS | 16 |
| Tuning parameters (except Transposer) | TUNING | 17 |
| Tremulants/Tremolos parameters | TUNING / TREMULANTS or TREMOLOS | 17 |
| Keyboards/Pedalboard Velocity | SETUP / KEYBOARDS / VELOCITY | 26 |
| Tracker Touch | SETUP / KEYBOARDS | 26 |
| Tracker Noises | SETUP / KEYBOARDS / TRACKER NOISE | 27 |
| Keyboards Inversion | SETUP / KEYBOARDS / INVERSION | 27 |
| 1st Short Octave | SETUP / KEYBOARDS / 1st SHORT OCTAVE | 28 |
| Crescendo enable | SETUP / CONTROLS | 30 |
| Reverb parameters | SETUP / AUDIO / REVERBERATION | 33 |
| Swells Range & Filter | available in the "Physis Plus The Editor" application | |

The Pipe Set menu

The PIPE SET menu contains all the functions for selecting and managing the Pipe Sets. To access to this menu, in the main video page,

1. press the [MENU/ENTER] button,
2. place the cursor on the PIPE SET field and press [MENU/ENTER].

The PIPE SET menu contains the following functions:



| Function | Description |
|-----------------|--|
| Select | Selection of a Pipe Set. |
| Copy/Rename | Copy of a Pipe Set allocating it in one of the available slots and rename. |
| Restore Default | Reset of a Pipe Set to the initial configuration. |

In this video page the Pipe Set currently selected appears in the bottom of the screen, also indicated in the lists of the Pipe Sets by the  symbol.

Selection of a Pipe Set (SELECT function)

To select a Pipe Set it is possible to follow two procedures:

- A. Using the [PIPE SET] thumb piston (in the models in which it is present) as described at page 6.
- B. In the main video page,
 1. press the [MENU/ENTER] button,
 2. select the PIPE SET field,
 3. select the SELECT field,
 4. select the desired Pipe Set from those displayed in the list.



Use the [^] and [v] buttons to move the cursor to other Pipe Sets, then press [MENU/ENTER] to confirm the new selection and make it usable, press [EXIT] to avoid the change and leave the currently selected Pipe Set.

NOTES

- The voice name printed on the drawnkobs / tabs is the voice recalled by the first Pipe Set.
- Please note that in general and divisional combinations, only the state of the stops is saved, and NOT which voice they activate. Selecting a Pipe Set might change the voices recalled by the stops, and therefore a combination may activate stops which were not saved as 'active'. It is a good practice to always remember which Pipe Set was active when saving a combination.

Copy or rename of a Pipe Set (COPY/RENAME function)

To copy a Pipe Set in an other location, follow this procedure:

1. in the main video page press the [MENU/ENTER] button,
2. select the PIPE SET field,
3. select the COPY/RENAME field,
4. select the Pipe Set you want to copy and press the [MENU/ENTER] button,
5. select the location where you wish to place the Pipe Set you are copying.
6. in the "AS" field you can assign a name to the Pipe Set you are copying. Use the [^] and [v] buttons to move the cursor, [+] and [-] to select the character.
Selecting the same Pipe Set location it is possible to rename an existing Pipe Set, without copy it in an other location.
7. press [MENU/ENTER] button to confirm the copy, or [EXIT] to quit.

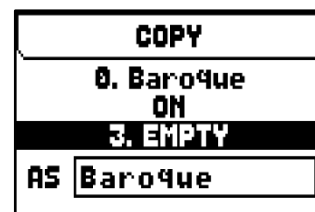

NOTES

- The content of an overwritten Pipe Set will be completely lost. To avoid this you can save in USB pen a file of the complete actual organ configuration using the SAVE SNAPSHOT function (see page 39) and reload it (also just the Pipe Sets) when necessary.
- To restore the original (factory) Pipe Sets it is necessary to perform a Factory Reset (see page 40).

Restore the original content of a Pipe Set (RESTORE DEFAULT function)

It is possible to undo the changes made to a Pipe Set, restoring its original content (not the factory content, but the one present at the time of copy). To do this, follow this procedure:

1. in the main video page press the [MENU/ENTER] button,
2. select the PIPE SET field,
3. select the RESTORE DEFAULT field,
4. select the Pipe Set you want to restore with the original content,
5. press [MENU/ENTER] button at the "Will reset all changes, are you sure?" message to confirm, or [EXIT] to quit.

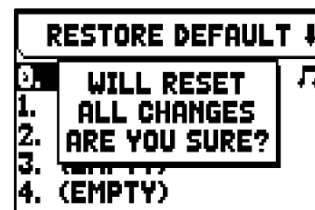

THE COMBINATIONS SETS

A Combinations Set contains all the memory banks and combinations, Tutti, Plenum and Crescendo steps, that can be selected directly on the instrument. By selecting a different Combination Set it is possible to use other memory banks and combinations, Tutti, Plenum and Crescendo steps. In an organ model with 99 banks and 10 combinations per bank for example, selecting another Combination Set makes another 99 banks and 10 combinations per bank, Tutti, Plenum and Crescendo steps available, replacing those of the previous Combination Set. This feature can be particularly useful in the case of use of the instrument by several musicians, so that everyone can use their own set of combinations. It is also possible to block the selection of a Combinations Set by entering a special code (PIN) so that only those who know it can use the Combinations Set.

NOTE

- The number of Combinations Sets available depends on the organ model purchased.
- In addition to the combinations, a Combination Set also contains the settings for managing them, described on page 31.

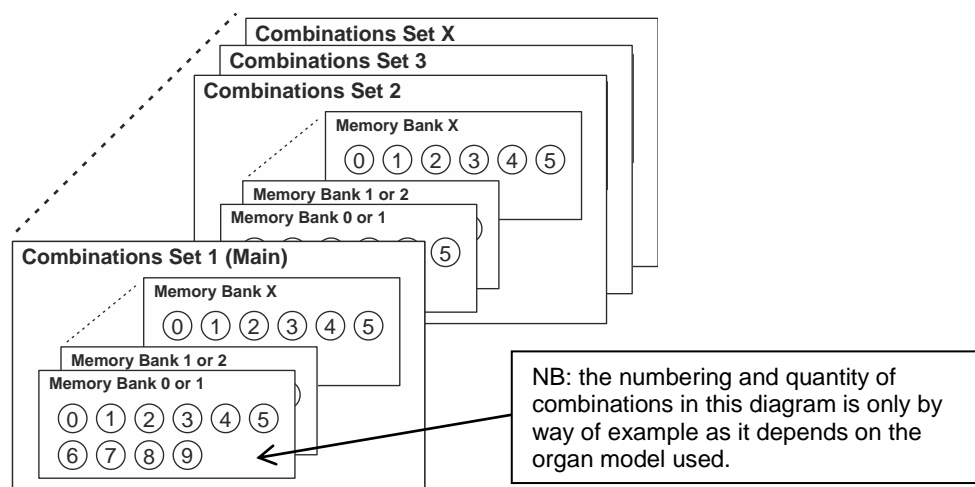

The Combinations menu

The COMBINATIONS menu contains all the functions for selecting and managing the Combinations Sets. To access to this menu, in the main video page,

1. press the [MENU/ENTER] button,
2. place the cursor on the COMBINATIONS field and press [MENU/ENTER].

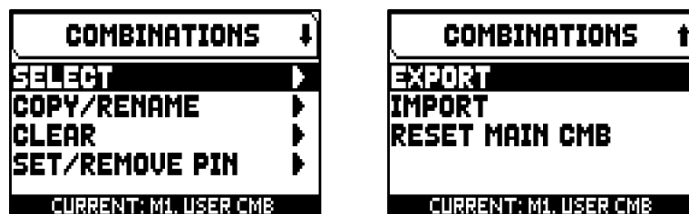

The COMBINATIONS menu contains the following functions:

| Function | Description |
|----------------|--|
| Select | Selection of a Combinations Set which consists in a package of all instrument's combinations. |
| Copy/Rename | Copy of a Combinations Set allocating it in one of the available slots and rename. |
| Clear | Deleting the contents of a Combinations Set. |
| Set/Remove PIN | Enter/delete a security code (PIN) to lock/unlock the editing of a Combinations Set. |
| Export | Saving a Combinations Set in a USB flash drive. |
| Import | Loading a Combinations Set from a USB flash drive allocating it in one of the available slots. |
| Reset Main CMB | Reset of the Main Combinations Set to the factory settings. |

In this video page the Combinations Set currently selected appears in the bottom of the screen, also indicated in the lists of the Combinations Sets by the symbol.

Selection of a Combinations Set (SELECT function)

To select a Combinations Set, follow this procedure:

1. in the main video page press the [MENU/ENTER] button,
2. select the COMBINATIONS field,
3. select the SELECT field,
4. select the desired Combinations Set from those displayed in the list and press the [MENU/ENTER] button. The first Combinations Set, also indicated as M1 (Main1), contains the first memory bank programmed by Viscount.

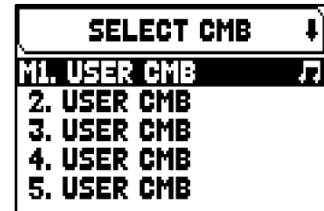

Copy or rename of a Combinations Set (COPY/RENAME function)

To copy a Combinations Set in an other location, follow this procedure:

1. in the main video page press the [MENU/ENTER] button,
2. select the COMBINATIONS field,
3. select the COPY/RENAME field,
4. select the Combinations Set you want to copy and press the [MENU/ENTER] button,
5. select the location where you wish to place the Combinations Set you are copying.
6. in the "AS" field you can assign a name to the Combinations Set you are copying. Use the [^] and [v] buttons to move the cursor, [+] and [-] to select the character. Selecting the same Combinations Set location it is possible to rename an existing Combinations Set, without copy it in an other location.
7. press [MENU/ENTER] button to confirm the copy, or [EXIT] to quit.

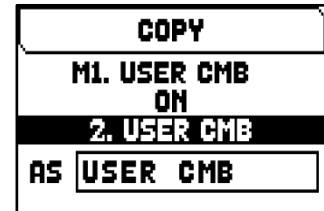

Deleting the contents of a Combinations Set (CLEAR function)

To delete the contents of an entire Combinations Set and so have all the combinations, Plenum, Tutti and Crescendo steps empty, follow this procedure:

1. in the main video page press the [MENU/ENTER] button,
2. select the COMBINATIONS field,
3. select the CLEAR field,
4. select the Combinations Set you want to copy and press the [MENU/ENTER] button,
5. press [MENU/ENTER] button at the "Will clear selected combination, are you sure?" message to confirm, or [EXIT] to quit.

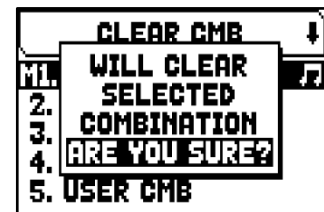

Insert a protection code (PIN) for a Combinations Set (SET PIN function)

To block any operation (selection, clear, overwrite) to a Combinations a protection code (PIN) can be inserted so that only those who know it can operate to the Combinations Set. To insert a PIN, follow this procedure:

1. in the main video page press the [MENU/ENTER] button,
2. select the COMBINATIONS field,
3. select the SET/REMOVE PIN field,
4. select the Combinations Set you want to lock and press the [MENU/ENTER] button,
5. in the SET PIN video page insert the four numbers of the PIN. Use the [^] and [v] buttons to move the cursor, [+] and [-] to select the number.
6. press [MENU/ENTER] button to confirm the PIN or [EXIT] to quit.
7. Now, in the list of the Combinations Sets, the symbol  is displayed next to the locked ones.



NOTE

It is not possible to insert a PIN for the Main Combinations Set.

To remove a PIN, in the list of Combinations Sets select the one you want to unlock, press the [MENU/ENTER] button and insert the PIN using the procedure described at point 5 (see above).

Saving a Combinations Set in a USB flash drive (EXPORT function)

To save a Combinations Set to a USB flash drive as a .CMB file, follow this procedure:

1. insert a USB flash drive in the left USB connector underneath the manuals,
2. in the main video page press the [MENU/ENTER] button,
3. select the COMBINATIONS field,
4. select the EXPORT field,
5. select the Combinations Set you want to save and press the [MENU/ENTER] button,
6. in the FILE NAME box you can modify the proposed .CMB file name. Use the [^] and [v] buttons to move the cursor, [+] and [-] to select the character.
7. press [MENU/ENTER] button to save (or [EXIT] to quit) and wait the "FILE SAVED" message. The .CMB file will be saved in the "v_settings" folder of the USB flash drive.



Loading a Combinations Set from a USB flash drive (IMPORT function)

To load a Combinations Set from a USB flash drive saved as a .CMB file using the EXPORT function (see above), placing it in one of the available location of the organ's internal memory, follow this procedure:

1. insert the USB flash drive with the .CMB file(s) in the left USB connector underneath the manuals,
2. in the main video page press the [MENU/ENTER] button,
3. select the COMBINATIONS field,
4. select the IMPORT field,
5. select the .CMB file of the Combinations Set you want to load and press the [MENU/ENTER] button,
6. select the location where you wish to place the Combinations Set you are loading, bearing in mind that the Combinations Set in the organ's internal memory location will be overwritten,
7. in the "AS" field you can assign a name to the Combinations Set you are loading. Use the [^] and [v] buttons to move the cursor, [+] and [-] to select the character.
8. press [MENU/ENTER] button to confirm the load, or [EXIT] to quit.

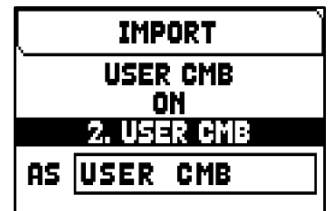

Reset the Main Combinations Set (RESET MAIN CMB function)

To restore the content of the Main Combinations Set to the factory settings as programmed by Viscount, follow this procedure:

1. in the main video page press the [MENU/ENTER] button,
2. select the COMBINATIONS field,
3. select the RESET MAIN CMB field,
4. press [MENU/ENTER] button at the "Restore Main Cmb to the factory settings, are you sure?" message to confirm, or [EXIT] to quit.



NOTES

- The content of an overwritten or cleared Combinations Set will be definitely lost. To avoid this you can save it in USB flash drive as a file using the EXPORT function and, if necessary, reload it using the IMPORT function (see below).
- Once the USB flash drive is inserted please wait some seconds before displaying the EXPORT or IMPORT menus. If the instrument still does not detect the drive, showing "USB PEN NOT FOUND" message, press [EXIT] to leave the menu and then try again.
- If a Combinations Set is protected by PIN, overwriting it with the IMPORT function, the display will show the message "COMBINATION TO OVERWRITE LOCKED BY PIN: PRESS ENTER TO UNLOCK". Press [MENU/ENTER] to insert the PIN and proceed with the overwrite or [EXIT] to quit.
- When connecting a new or just formatted USB flash drive to the organ, the system will automatically create two directories in the drive: "v_settings" and "v_songs". The system needs these two folders to arrange files, and they must not be deleted or renamed, otherwise the saved files will be lost. The system will save the Combination Sets as .CMB file in the "v_settings" directory. Please pay attention not to delete or rename this folder to avoid losing or making unusable the recordings.
- Always use USB flash drive formatted with FAT or FAT32 file system (no NTFS).
- If you wish to rename .CMB files saved to the USB stick using a computer, always make sure that the names can be a maximum of 12 characters (including those before the "_") and cannot contain special characters such as "_", "@", "#", etc.

SETTING THE VOLUMES (LEVELS menu)

The Physis Plus organs allow the user to adjust several volumes, in order to obtain a perfect sound balance among the sections and between internal and external amplifications.

To display the volumes video page, press the [LEVELS] button:

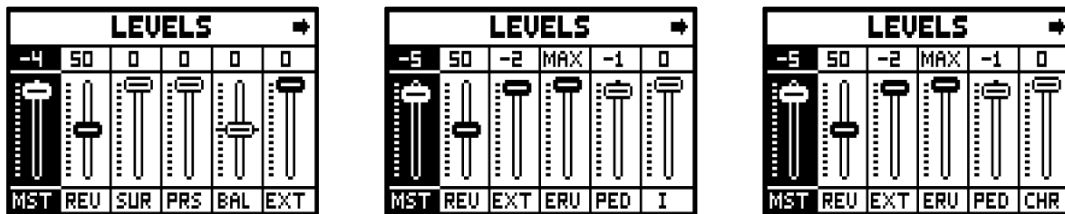

The settings which can be made are:

| Parameter name | Description |
|--|---|
| MST (Master) | Organ's overall volume, which can also be adjusted with the [MASTER VOLUME] knob underneath the manuals.. Settings: Off, -59 dB to 0 dB |
| REV (Reverb) | Reverb effect level on the internal amplification, which can also be adjusted using [+] / [-] buttons when the main page is displayed (see page 9). Settings: Dry, 1 to 99, Wet |
| SUR (Surround) | Volume of the side speakers expands the sound stage, giving the feeling of being in a bigger environment. Settings: Off, -59 dB to 0 dB NOTE <i>Not present in the organ models without side speakers.</i> |
| PRS (Presence) | Volume of the front side speakers makes the sound more natural and detailed, emphasizing on the dynamic evolution of the pipes sound. Settings: Off, -59 dB to 0 dB NOTE <i>Not present in the organ models without additional front speakers.</i> |
| BAL (Balance) | Stereophonic balance of the side speakers. Settings: 63L to 63R NOTE <i>Not present in the organ models without side speakers.</i> |
| EXT (External outputs) | General volume of the PROG. OUT connectors of the rear panel. Settings: Off, -59 dB to 0 dB NOTE <i>Not present in the organ models without side speakers.</i> |
| ERV (External reverb) | Reverb effect level on the PROG. OUT connectors of the rear panel. Settings: Dry, 1 to 99, Wet |
| PED (Pedalboard) | Pedalboard divisional volume. Settings: -18 to 0 |
| II or GRT (Manual II or Great) | Manual II or Great divisional volume. Settings: -18 to 0 |
| III or SWL (Manual III or Swell) | Manual III or Swell divisional volume. Settings: -18 to 0 |
| I or CHR (Manual I or Choir) | Manual I or Choir divisional volume. Settings: -18 to 0 |
| IV or SOL (Manual IV or Solo) | Manual IV or Solo divisional volume. Settings: -18 to 0 |
| ORC (Orchestra) | Volume of the orchestral voices. Settings: -18 to 0 |

Press [EXIT] or [LEVELS] or wait about 4 seconds to quit the screen and return to the previous video page.

TUNING THE INSTRUMENT (TUNING menu)

The TUNING menu gives access to all the instrument's tuning parameters.

To access to this menu, in the main video page,

1. press the [MENU/ENTER] button,
2. place the cursor on the TUNING field and press [MENU/ENTER].

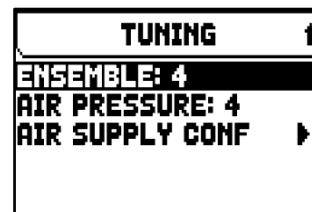

The settings which can be made are:

| Parameter name | Description |
|--|---|
| Transposer | General instrument transposition by semitones. Settings: -6 to +5 NOTES - When switched on, the organ's transposition is always set at 0. - Transposition does not have any effect on playback of pieces with the internal sequencer (unlike recording, where the notes are acquired with the current transposition). A specific transposer is provided for this purpose (see page 48) |
| Pitch | General fine tuning, indicated as the frequency of A4 (based on a 8' pitch stop). Settings: 415,3 Hz (-100 cents) to 466,16 Hz (+100 cents) |
| [third field on the display] ("Equal" in the screen shown above) | Selector for setting historical temperaments of various periods and countries of origin. Settings: Equal, Kirnberger II, Werckmeister III, Pythagorean, Meantone 3#, Vallotti, Chaumont, Kellner 1975, Kirnberger III, Werckmeister IV, Werckmeister V, Silbermann, Meantone 3b, Meantone Purem3rd, Zarlino, Sauver 1, Sauver 2, Barca, Neidhardt II, Custom 1, Custom 2, Custom 3, Custom 4 NOTE Custom temperaments are programmable. See below. |
| Base Key | Key on which the chain of 12 fifths that make up the temperament starts. Settings: C to B |
| Tremulants Tremolos | Setting parameters of each tremulant (see below). |
| Ensemble | Level of tiny natural differences in pitch between one organ pipe and another, simulating the tuning error that occurs in the organ's pipes due to wear over time and variations in temperature. Settings: 0 (pipes perfectly tuned) to 8 (maximum pitch instability) |
| Air Pressure | Simulates the drop in air pressure when a large quantity of air is requested in a short time (e.g. when large chords are played with the Tutti). This is reflected in a temporary, gradual drop in pitch, more evident in the longest, widest pipes (flutes, bourdons, principals). Settings: 0 (no drop of air pressure) to 8 (maximun drop of air pressure) |
| Air Supply Conf | Fine adjustment of the AIR PRESSURE parameter (see above). |

Programming Custom temperament

In addition to the historical temperaments it is possible to program up to 4 custom temperaments, adjusting the pitch difference with respect to the Equal temperament for each note of the octave. To program a temperament, select one of the four CUSTOM items in the display field and press [MENU/ENTER].

In the video page the 12 notes of the octave are shown and the variation in 0.1 cents of semitone in a range from -50 to +50 cents. After making the desired adjustments, press [EXIT] to store them in the previously selected CUSTOM temperament and return to the TUNING screen.

| CUSTOM 1 (cents) | | | |
|------------------|-----|----|-----|
| C | 0.0 | F# | 0.0 |
| C# | 0.0 | G | 0.0 |
| D | 0.0 | G# | 0.0 |
| D# | 0.0 | A | 0.0 |
| E | 0.0 | A# | 0.0 |
| F | 0.0 | B | 0.0 |

Adjusting the tremulants/tremolos (TREMULANTS/TREMOLOS function)

In a pipe organ it is of the utmost importance that the air pressure remain constant, so as to obtain a steady and sustained sound. However, mechanical devices were introduced to generate periodical variations in the air flow. These variations created the “tremulant” effect on the sound, which made some lead registers (such as Vox Humana) more pleasant, and the tone of the reeds colourful.

Physis Plus organs have two tremulants/tremolo for each section so as to customise further the sound, or to add more tremulant/tremolo to certain registers, such as Vox Humana. Access the VOICING function under the MAIN MENU (see page 20) to select which tremulant/tremolo will be applied to each register.

To access the video page for tremulant/tremolo adjusting, in the TUNING menu place the cursor on the TREMULANS or TREMOLOS field and press [MENU/ENTER].

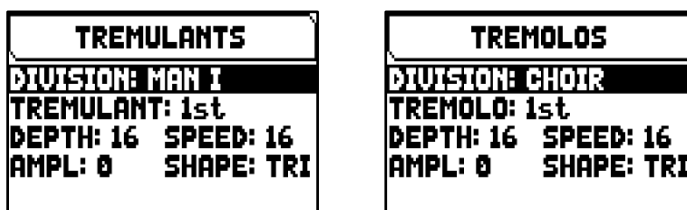

The settings which can be made for the tremulants/tremolo are:

| Parameter name | Description |
|--------------------------|---|
| Division | Organ division whose tremulant/tremolo you want to adjust. Settings: [organ division] |
| Tremulant Tremolo | Tremulant/tremolo you want to adjust. Settings: 1st, 2nd |
| Depth | Tremulant/tremolo modulation depth. Settings: 4 to 32 |
| Speed | Tremulant/tremolo modulation speed. Settings: 4 to 32 |
| Ampl | Tremulant/tremolo modulation amplitude. Settings: 0 to 7 |
| Shape | Tremulant/tremolo modulation waveform. Settings: TRI (triangle), SIN (sine) |

NOTE

Tremulant/tremolo parameters can be saved with different values for each general or divisional combination and for the Tutti. To do so, activate this function in the SETUP / COMBINATIONS menu (see page 31).

Fine adjustment of the AIR PRESSURE parameter (AIR SUPPLY CONFIG function)

As already reported in the descriptions of the parameters in the TUNING page, by means of the AIR PRESSURE parameter, the organ allow to simulate the air pressure drop when a large quantity is required suddenly.

Through the AIR SUPPLY CONFIG function it is possible to further customize the behavior of this parameter, selecting five different operating modes, each of which simulates the behavior of the "wind distribution system" of a particular type of pipe organ and regulating its influence separately for each organ section.

To access the adjustment screen, select the AIR SUPPLY CONF field in the TUNING menu:

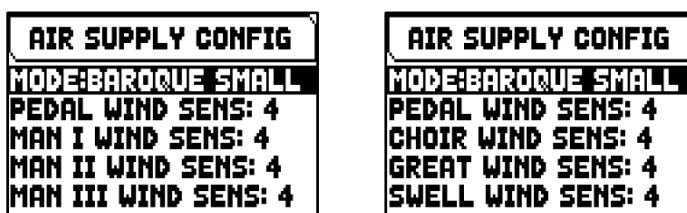

The settings which can be made are:

| Parameter name | Description |
|--------------------------------------|---|
| Mode | Operating modes of the AIR PRESSURE. Settings: <ul style="list-style-type: none"> • Standard: no change to the behavior set in the TUNING page. • Baroque Small: behavior of a small baroque organ, with particularly sensitive and unstable air supply. • Baroque Large: behavior of a large baroque organ, more stable and with a slower response to transients than BAROQUE SMALL, but still rather sensitive. • Romantic: behavior of a great romantic / symphonic organ, with a rather stable air supply, but with a notable "ensemble" effect when big chords are played. • Gently Flexible: behavior of an organ equipped with flexible air supply, which influences the instrument in a delicate way. |
| [organ division] Wind Sens | Intensity of the effect for each organ division. Settings: 0 to 8 |

SELECTING AND REGULATING THE VOICES (VOICING menu)

One of the main features of the Physis Plus synthesis technology is that it offers the user a wide array of options for customising the instrument with a very large number of organ timbres, and also makes available several parameters which can be adjusted to further increase the setup potential.

The VOICING menu contains all the functions for selecting and regulating the voices' audio parameters. To access to this menu, in the main video page,

1. press the [MENU/ENTER] button,
2. place the cursor on the VOICING field,
3. press [MENU/ENTER] or hold down/out for a few moments the tab (in the ON position) or drawknob of stop you wish to edit.

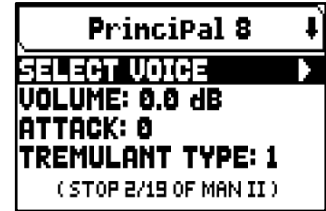



Once you have entered the VOICING video page, you can select other stops to edit, using the tab or drawknob in the same way explained above. The Led of the stop being modified will flash to prevent modification errors; the stop will be on and can be played for better, quicker adjustment. Other stops can also be switched on to assess the overall effect of the changes.

NOTES

- *The voices selected for each stop and the sound generation parameters are automatically saved in the current Pipe Set. This means that when another Pipe Set is recalled, the voices will be reset with new parameters taken from the last Pipe Set recalled. The changes made earlier are not lost, and will be made available when the style in which they were made is selected again.*
- *While adjusting the VOICING parameters, in order to assign a voice to a stop and to adjust it, we advice to select the desired voice first and then to adjust its generation parameters. Please do so, as when a new voice is selected, its parameters are reset to default values.*

The screen-printed on the drawknob or tab being edited is shown at the top of the VOICING video page.

The SELECT VOICE field allow you to access to the list of alternative voices. In this list the currently selected voice is indicated by the  symbol. When the [^] and [v] buttons are used to move the cursor to other voices, the  symbol will be moved as soon as the new voice can be played to be evaluated immediately. Other stops can also be switched on to assess the overall effect of the changes. Press [MENU/ENTER] to confirm the new voice and make it usable, press [EXIT] to avoid the change and reselect the previous voice.

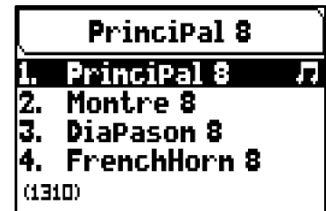

In the VOICING video page, below the SELECT VOICE field, are displayed the main sound generation parameters of the selected stop. The parameters displayed are not the same for every voice, since some families have specific setting parameters not required for other types of voice.

The settings which can be made are:

| Parameter name | Description |
|--|--|
| Volume | Stop volume. Settings: -12 dB to +12 dB |
| Attack | Attack time the sound takes to reach the maximum volume. Settings: -4 to +4 |
| Tremulant Type Tremolo Type | Select which tremulant modulates the stop. Settings: <ul style="list-style-type: none"> • Off: tremulant is not applied to the stop. • 1st: 1st tremulant. • *1st*: 1st tremulant automatically applied to the stop when it will be switched on. • 2nd: 2nd tremulant. • *2nd*: 2nd tremulant automatically applied to the stop when it will be switched on. |
| Tremulant Sens. Tremolo Sens. | How much the tremulant affect the stop. Settings: 0 to 8 |
| Ensemble Rescale | Rescaling of the overall ensemble set with the ENSEMBLE parameter (see page 17). Settings: 0 to 8 |
| Character (not for mixture voices) | Harmonic richness. Settings: -8 to +8 (flue and mixture voices), 4 to +4 (reed voices) |

| | |
|--|---|
| Ranks Balance (mixture voices only) | Octave – Fifth ranks balance. Settings: -8 to +8 |
| Noise (only flue voices) | Noise of the air blowing through the pipe. Settings: -4 to +4 |
| Aeolian Chiff (not for reed voices) | Chiff noise at the key attack. Settings: -4 to +4 |
| Celeste Type (detuned voices only) | Types of beating. Settings: Orig (original), A-, A+, B-, B+, C-, C+ (different detuning curves) |
| Celeste Depth (detuned voices only) | Depth of beating. Settings: 0 to 8 |
| Mix Brilliance (mixture voices only) | Mixture brilliance. Settings: 0 to 8 |
| Ranks Swirl (mixture voices only) | Random pitch lock/unlock between the different pipe ranks. Settings: 0 to 8 |
| Wavering (not for mixture voices) | Random pitch variations. Settings: 0 to 8 |
| Frequency Skew (reed voices only) | Gradual pitch variation in the attack and release phases. Settings: 0 to 8 |
| Release Detune (not for reed voices) | Gradual pitch variation in the release phase. Settings: 0 to 8 |
| Int. Chest | Voices stereophonic reproduction (panning) in the internal amplification (see below). Settings: C-C#, C#-C, Wing L (left), Wing R (right), Cusp, Dbl Csp (double cusp), Dbl (double) Wing, Pan L (left), Pan R (right), Center, Poly, Off |

NOTE
Several sound generation parameters are available in the “Physis Plus The Editor” application for a more advanced customization of each voice.

Explanation of the INT. CHEST (Internal Windchest parameter)

An important option to customize the sound configuration of the organ is to arrange the voices’ stereophonic reproduction (this is also called panning).

The organ is equipped with one or more left and right internal audio channels. The simultaneous diffusion through both channels simulates a third, central channel.

Arranging the voices in the two channels simulates the position of the windchests of real pipe organs, since they were usually placed in different areas. It also simulates the different position of the pipes inside the windchest, which could vary according to the stop played, the period when the organ was built and the wishes of the builder.

The following options are available:

| Int. Chest | Description |
|-------------|--|
| C-C# | <p>The notes sound alternated (one right, one left) from C (left) to C# (right).</p> |
| C#-C | <p>The notes sound alternated (one right, one left) from C (right) to C# (left).</p> |

| | |
|--|---|
| <p>Wing L (Wing Left)</p> | <p>The tallest, broadest pipes are installed on the left, so the lowest notes are played by the speakers furthest to the left. As the pitch rises the notes are played more and more to the right.</p> |
| <p>Wing R (Wing Right)</p> | <p>The tallest, broadest pipes are installed on the right, so the lowest notes are played by the speakers furthest to the right. As the pitch rises the notes are played more and more to the left.</p> |
| <p>Cusp</p> | <p>The tallest, broadest pipes are located in the centre, so the voice's lowest notes are played by the most central speakers. As the pitch rises the signal is gradually distributed further and further to the outside, alternating.</p> |
| <p>Dbi Cusp (Double Cusp)</p> | <p>There are two separate cusps, both resembling to the single cusp described above. The lowest keys sound in an intermediate position, between the centre and the outside, alternating (one on the right cusp, one on the left cusp). As the pitch rises, rises the signal is gradually distributed further and further to the outside, alternating.</p> |
| <p>Dbi Wing (Double Wing)</p> | <p>The highest notes sound in the centre. As the pitch lowers, the signal is gradually distributed further and further to the outside, alternating.</p> |

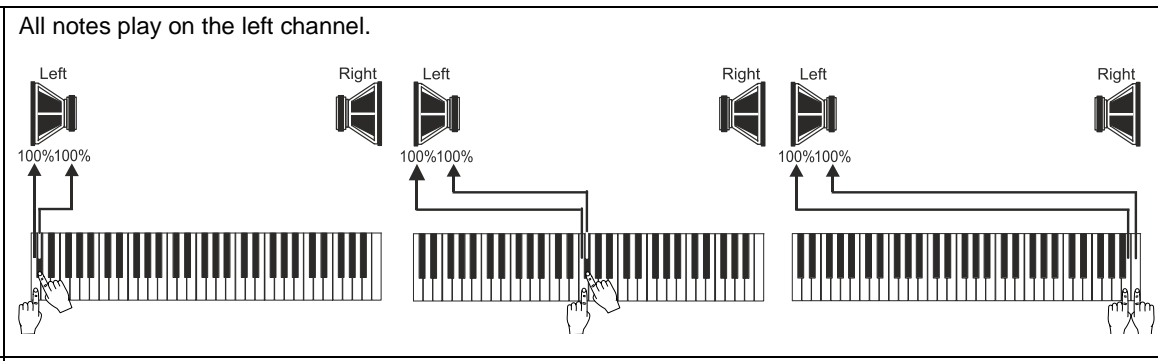
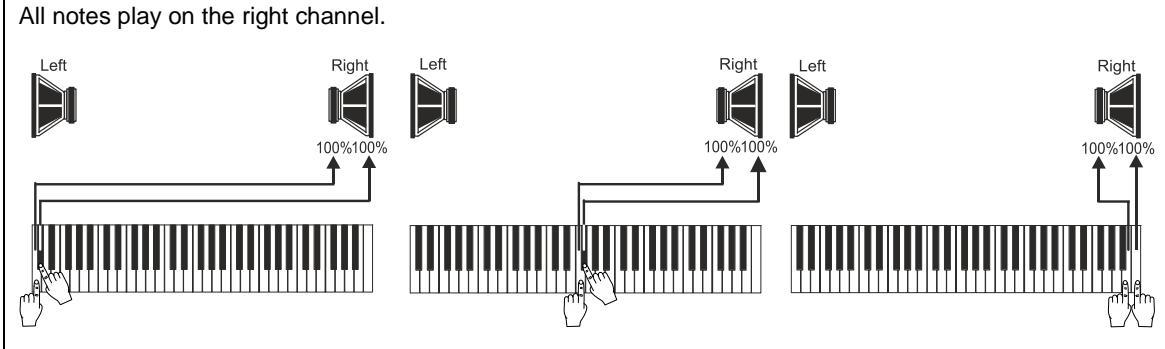
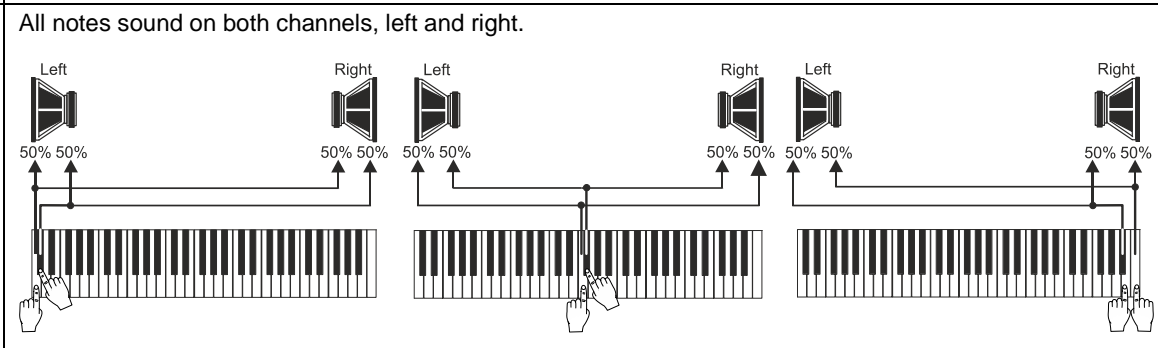
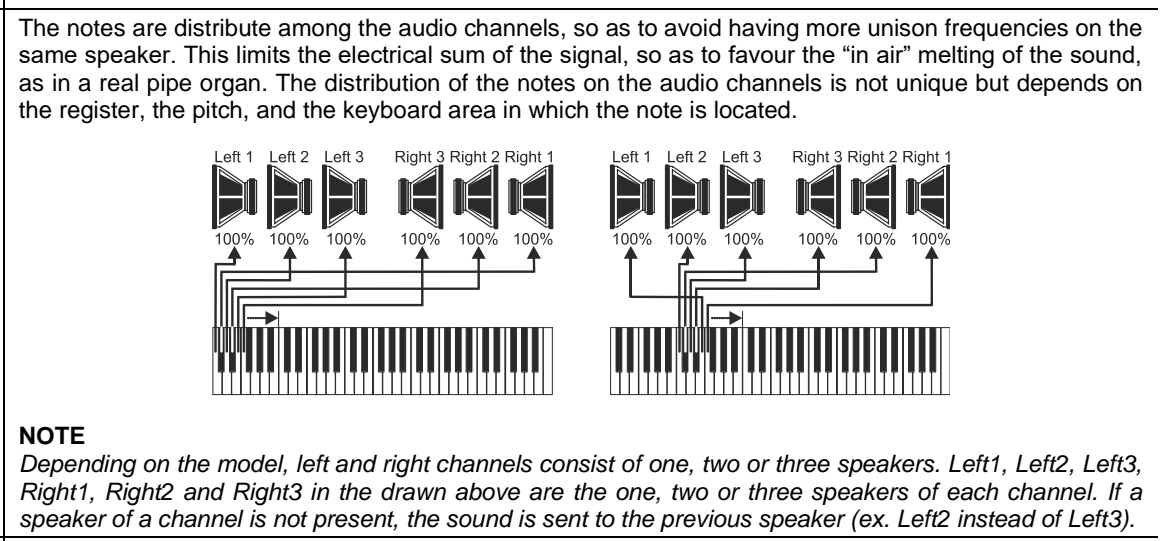
| | |
|---|---|
| <p>Pan L (Pan Left)</p> | <p>All notes play on the left channel.</p>  |
| <p>Pan R (Pan Right)</p> | <p>All notes play on the right channel.</p>  |
| <p>Center</p> | <p>All notes sound on both channels, left and right.</p>  |
| <p>Poly (Alternating polyphonic)</p> | <p>The notes are distribute among the audio channels, so as to avoid having more unison frequencies on the same speaker. This limits the electrical sum of the signal, so as to favour the “in air” melting of the sound, as in a real pipe organ. The distribution of the notes on the audio channels is not unique but depends on the register, the pitch, and the keyboard area in which the note is located.</p>  <p>NOTE Depending on the model, left and right channels consist of one, two or three speakers. Left1, Left2, Left3, Right1, Right2 and Right3 in the drawn above are the one, two or three speakers of each channel. If a speaker of a channel is not present, the sound is sent to the previous speaker (ex. Left2 instead of Left3).</p> |
| <p>Off</p> | <p>Not played with the internal amplification.</p> |

NOTE
For further informations about the types of pipe windchests and how they work, see page 57.

Selecting and adjusting the orchestral voices

The same operations described in the chapter above can be performed also with orchestral voices, with a single exception: the list of alternative voices and audio parameters are the same, regardless of which register is selected at the moment. To access the VOICING menu for the orchestral voices, follow the same procedure described at the beginning of this chapter.



As you may notice in the voices list, there are three types of orchestral stops:

- **Single:** a single stop played on the whole manual / pedalboard. This kind of voice is shown with the name of the single stop.
- **Split:** two stops (named Left and Right) played in two different halves of the manual / pedalboard. The split point can be changed. This kind of voice is shown as the names of the two stops hyphenated.
- **Layer:** two stops (named 1 and 2) overlapped along the whole manual / pedalboard. This kind of voice is shown as the names of the two stops with a “+” in between.

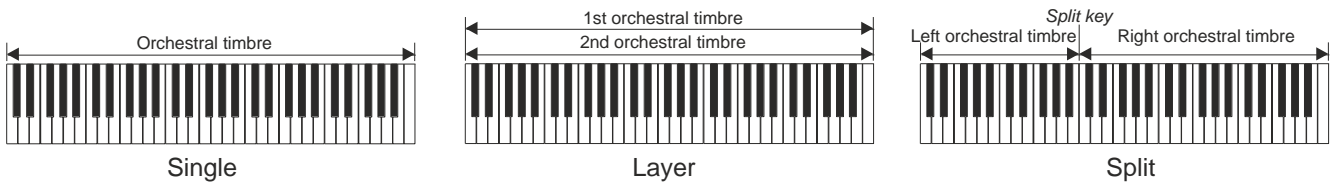

The settings which can be made are:

| Parameter name | Description |
|---|--|
| Volume | Stop volume. Settings: -12.0 dB to +12.0 dB |
| Brilliance | Sound brilliance. Settings: -8 to 8 |
| Oct. Shift | Shift the notes played with the stop one octave higher or lower. Settings: -1 to 1 |
| Sustain | Sets the status of the sustain pedal. This function is useful for those orchestral voices for which applying a sustain effect is unrealistic. Select NO to prevent the sustain effect from affecting the stop. Settings: Yes, No |
| Pan | Stereophonic distribution of the sound. Settings: -6 L (left) to 6 R (right) |
| Split Key (splitted double voices only) | Split point key. Settings: F2 to E6 |

The sound parameters that can be modified are shown in a different manner, according to the kind of voice.

Parameters of the Single voices clearly relate to the single stop.

Parameters of the Split voices identified by “LEFT” relate to the stop active on the left of the split point, while parameters identified with an “RIGHT” relate to the stop active on the right half of the manual / pedalboard.

Parameters of the Layer voices identified with “1st” relate to the first stop of the voice (the one before the “+” symbol). Parameters identified with “2nd” relate to the second stop, after the “+” symbol.

Saving different orchestra voices and parameters in the combinations

General and divisional combinations make possible to save the voice and the settings for each Orchestra stop, so that different voices can be played for each combination (including the Tutti). For example, recalling a previously programmed combination, the pedal Orchestra voice may be an acoustic bass, with a 1-octave transposition, while using a second combination the Pedal Orchestra voice may be a cello, with no transposition, but a bit brighter than the standard setup.

To program combinations with different Orchestra voices, first of all you have to enable the saving, setting the ORCHESTRA PARAMS IN COMBINATIONS parameters in the SETUP / COMBINATIONS menu (see page 31) as “YES”.

Now, simply select the required voice and/or adjust the parameters keeping pressed for a few moments the Orchestra tab / drawknobs that you desire to edit in the position of voice ON, while the main video page is displayed. The video page that is displayed is the same as the one described above.

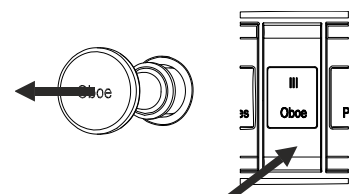

After Orchestra sounds are programmed it is possible to store them in the desired combination. If you wish to set a different Orchestra sound in a different combination but associate it to the same register, enter the edit menu, select the voice, adjust the parameters as required and save all the settings in another combination. Keep in mind that once a different orchestral sound is selected, it will be associated to that stop also when future combinations are saved, even if the stop is saved as "off".

If the orchestral sound has been changed and/or its parameters have been modified and these changes have been saved in a combination, when the combination is recalled and the register is turned on, the name of the orchestral voice is displayed between two asterisks to highlight that the stop no longer recalls the voice expected from the Pipe Set.



After an Orchestra stop has been set by recalling a combination, it is still possible to immediately restore the voice and parameters of the current Pipe Set by keeping pressed for a few moments the tab / drawknobs in the position of voice OFF.

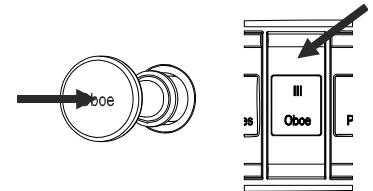

NOTES

- *The changes applied to the Orchestra sounds with this procedure are not applied to Orchestra voices used by the current Pipe Set and their settings. Selecting another Pipe Set or displaying the video pages of the VOICING menu, will set the Orchestra registers as prescribed by the Pipe Set and not by the combinations.*
- *While adjusting the VOICING parameters, in order to assign a voice to a stop and to adjust it, we advice to select the desired voice first and then to adjust its generation parameters. Please do so, as when a new voice is selected, its parameters are reset to default values.*
- *To save the same orchestral voice and its parameters equal to those of the Pipe Set in the combination, you must enter the edit orchestra screen at least once, otherwise the instrument will save in the combination only the On/Off status of the stop and not the desired orchestral voice and its parameters. Saving a memory without viewing the orchestra edit screen saves the On/Off status of the stops, but not the voice and the parameters which therefore will always be those of the selected Pipe Set (verifiable on the main page from the name of the voice displayed without asterisks).*

KEYBOARDS SETTINGS (SETUP / KEYBOARDS menu)

The KEYBOARDS menu contains all the settings relating to the manuals and their function modes.

To access to this menu, in the main video page,

1. press the [MENU/ENTER] button,
2. place the cursor on the SETUP field and press [MENU/ENTER],
3. place the cursor on the KEYBOARDS field and press [MENU/ENTER].

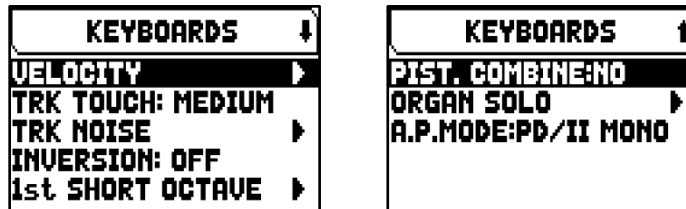

The KEYBOARDS menu contains the following settings:

| Function | Description |
|--|--|
| Velocity | Velocity of the manuals and pedalboard when using Orchestra stops and transmitting MIDI note messages. |
| Trk Touch (Tracker Touch) | Simulates the typical tracker touch of mechanical organs that affects the attack and release times and the sound character in these phases, with four selectable degrees of sensibility. Settings: No, Simple, Light, Medium, Heavy |
| Tracker Noise | Enable/disable, selection and regulation of the tracker noise, i.e. the mechanical noise produced by the keys as they are pressed while playing a real antique mechanical organ. |
| Inversion | Enable/disable and configuration of the Keyboards Inversion function, through which the stops for one section play on a selected manual. |
| 1st Short Octave | Enable/disable and configuration of the Short Octave for each manual and pedalboard. |
| Pist. Combine (Piston Combine) | Enable/disable and configuration of the Piston Combine function that synchronizes manuals and pedalboard divisional combinations. NOTE <i>This function is only available for organ models equipped with divisional combinations.</i> |
| Organ Solo | Configuration of [ORGAN SOLO] or [ORG SOLO] thumb piston operating mode. NOTE <i>This function is only available for organ models equipped with [ORGAN SOLO] or [ORG SOLO] thumb piston.</i> |
| A.P. Mode | Selection of the [AUTO PEDAL] or [AUTO PED] thumb piston operating mode. |

Setting the keyboards / pedalboard velocity (VELOCITY function)

This function sets the velocity of the notes transmitted through MIDI [OUT] port and played with Orchestra stops, for manuals and pedalboard.

To access the adjustment screen, select the VELOCITY field in the KEYBOARDS menu:

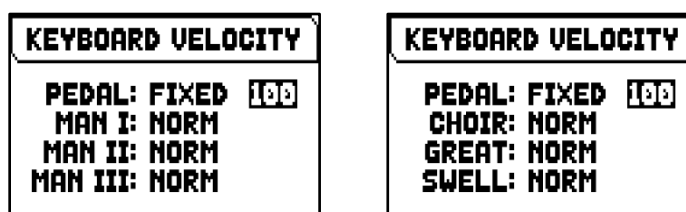

The settings which can be made are:

| Parameter name | Description |
|------------------|--|
| [organ division] | Keyboards / pedalboards velocity. Settings: Soft-Normal-Hard (dynamic curves), Fixed (from 1 to 127) NOTE <i>Soft, Normal and Hard curves are not available for the Pedal section.</i> |

Adding the keyboards / pedalboard keys mechanical noises (KEYBOARDS NOISE function)

The organs of the Physis Plus series allow you to simulate the noises generated by the mechanical systems of the keyboards and pedals and their connections to the pipe valves, present in the antique mechanical pipe organs. In addition to being able to choose the type of organ and therefore the mechanism whose noises are simulated, it is possible to adjust the volume, attack time and distribution of the noise along the keyboard.

To access the adjustment screen, select the TRK NOISE field in the KEYBOARDS menu.



The settings which can be made are:

| Parameter name | Description |
|---|--|
| [organ division] ("Pedal:" in the screen shown above) | Organ division to edit. Settings: [organ division] |
| [noise status] ("Enabled:" in the screen shown above) | Enable/disable the noise for the selected organ division. Settings: Enabled, Disabled |
| [noise type] ("Romantic A" in the screen shown above) | Noise type. Settings: Barker A-B-C-D (non dynamic noises), Baroque A-B-C-D-E-F , Romantic A-B-C (dynamic noises) |
| Vol (dB) | Noise volume of the key pressed (↓) and key released (↑) Settings: -12,0 to +12,0 |
| Attack | Attack time of the key pressed (↓) and key released (↑) Settings: -4 to +4 |
| Int. Chest (Internal Windchest) | Voices stereophonic reproduction (panning) in the internal amplification (see below). Settings: C-C#, C#-C, Wing L (left), Wing R (right), Cusp, Dbl Csp (double cusp), Dbl (double) Wing, Pan L (left), Pan R (right), Center, Poly, Off NOTE <i>For further informations about the Internal Windchest, see page 21.</i> |

Configuring of the Keyboards Inversion function (INVERSION function)

This function allow to invert the manuals, so that the stops of one section play on a selected manual.

To activate the inversion, in the KEYBOARDS menu select "ON" in the INVERSION field.

To select a manual, select this field and press [MENU/ENTER]:



The display shows graphically the organ manuals with, next to them, the corresponding organ section when the Keyboards Inversion function is active. Using the [^] and [v] buttons it is possible to move the cursor and position it in correspondence with the manual to be associated with the section, using the [+] and [-] buttons.

Enabling of the Short Octave (1st SHORT OCTAVE function)

This function makes the first octave on manuals and pedalboard short, so as to perform pieces written for ancient organs (16th to 18th century) in which the first octave was shortened.

To access the adjustment screen, select the 1st SHORT OCTAVE field in the KEYBOARDS menu:

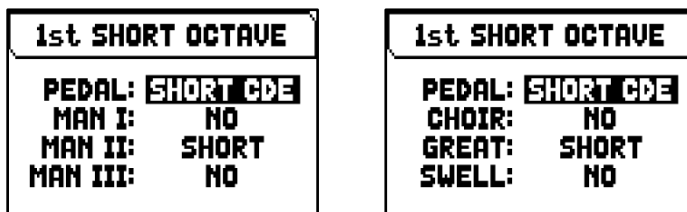

The settings which can be made are:

| Parameter name | Description |
|------------------|---|
| [organ division] | <p>Enable/disable the Short Octave. Settings: No, Short, Short CDE (Pedal only)</p> <div style="display: flex; justify-content: space-around; align-items: flex-end;"> <div style="text-align: center;"> <p>SHORT</p> </div> <div style="text-align: center;"> <p>SHORT CDE</p> </div> </div> |

Synchronizing of the divisional combinations (PISTON COMBINE function)

It is possible to synchronize the thumb pistons of the manuals and pedalboard divisional combinations, so that by selecting one combination automatically the same one of the connected section is recalled.

To enable the Piston Combine, in the KEYBOARDS menu set the PIST. COMBINE field as follow:

- **KB->P**: when a manual combination is selected, the same is recalled on the pedalboard.
- **P->KB**: when a pedalboard combination is selected, the same is recalled on the manual.
- **KB+P**: when a combination on either pedalboard or manual is selected, the same is recalled on the other section.

To select which manual will be synchronized, after one of the operating modes described above is selected press [MENU/ENTER]:

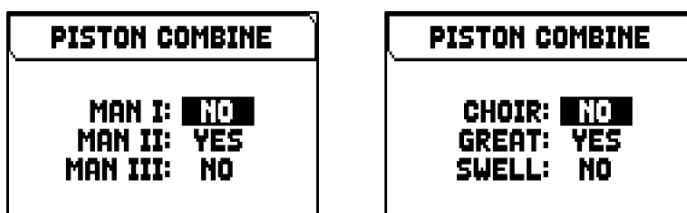

The settings which can be made are:

| Parameter name | Description |
|------------------|---|
| [organ division] | <p>Enable/disable the Piston Combine for the selected organ division. Settings: No, Yes</p> |

Configuring of the Organ Solo function (ORGAN SOLO function)

This function allows you to customize the Organ Solo function, activated by the [ORGAN SOLO] or [ORG SOLO] thumb piston.

To access the adjustment screen, select the ORGAN SOLO field in the KEYBOARDS menu and press [MENU/ENTER]:



The settings which can be made are:

| Parameter name | Description |
|---|--|
| Source Keyb (Source Keyboard) | Manual on which you physically play. Settings: [organ division] |
| Dest. Keyb (Destination Keyboard) | Organ division playing the melody when the Organ Solo function is active. Settings: [organ division] |
| Footage Mode | Footage on the Organ Solo function. Settings: <ul style="list-style-type: none"> • Auto: melody is played in 8' footage activating the coupler of the Destination Keyboard to the Source Keyboard. • 16': melody is automatically played one octave lower. • 8': melody is automatically played in unison. • 4': melody is automatically played one octave higher. |
| First Key | Lowest key from which to start playing the melody. Settings: C2 to C7 |

Setting the Automatic Pedal mode (A.P. MODE parameter)

It is possible to select the Automatic Pedal function operating mode, activated with the [AUTO PEDAL] or [AUTO PED] thumb piston.

To do this, in the KEYBOARDS menu set the A.P. MODE field as follow:

| Parameter name | Description |
|--|--|
| A.P. Mode (Automatic Pedal mode) | Automatic Pedal function operating mode. Settings: <ul style="list-style-type: none"> • Ped. A.Piano: activate the Pedal Automatic Piano mode. This function automatically adjusts the sound composition of the pedalboard, according to the manual currently played. • Pd/Kb Mono: activate the Mono Pedal function which allows you to play the Pedalboard voices on all the manuals. When doing this the pedalboard is deactivated and the stops become monophonic, with priority on the lowest note. • Pd/II Mono or Pd/Gt Mono: Pedalboard voices are played on Manual II or Great. When doing this the pedalboard is deactivated and the stops become monophonic, with priority on the lowest note. • Pd/III Mono or Pd/Sw Mono: Pedalboard voices are played on Manual III or Swell. When doing this the pedalboard is deactivated and the stops become monophonic, with priority on the lowest note. • Pd/I Mono or Pd/Ch Mono: Pedalboard voices are played on Manual I or Choir. When doing this the pedalboard is deactivated and the stops become monophonic, with priority on the lowest note. |

ORGAN CONTROLS SETTINGS (SETUP / CONTROLS menu)

The CONTROLS menu contains all the settings relating to the controls available in the organ console.

To access to this menu, in the main video page,

1. press the [MENU/ENTER] button,
2. place the cursor on the SETUP field and press [MENU/ENTER],
3. place the cursor on the CONTROLS field and press [MENU/ENTER].



The CONTROLS menu contains the following settings:

| Parameter name | Description |
|--|---|
| ENC Config SWS Config | <p>Select the expression pedal that regulates the volume of each section while the [ENC] or [SWS] piston is on. To access the adjustment screen, press [MENU/ENTER] while ENC CONFIG or SWS CONFIG field is displayed:</p> <div style="display: flex; justify-content: space-around; align-items: center;"> <div style="border: 1px solid black; padding: 5px; text-align: center; width: 150px;"> <p>ENC CONFIG</p> <p>PEDAL ← III</p> <p>MAN I ← III</p> <p>MAN II ← III</p> <p>MAN III ← III</p> </div> <div style="border: 1px solid black; padding: 5px; text-align: center; width: 150px;"> <p>SWS CONFIG</p> <p>PEDAL ← SWL</p> <p>CHOIR ← SWL</p> <p>GREAT ← SWL</p> <p>SWELL ← SWL</p> </div> </div> <p>The organ sections can be found on the left side, while on the right the expression pedal can be selected.</p> |
| Swellbox Steps | <p>Number of expression pedal steps for each organ division To access the adjustment screen, press [MENU/ENTER] while SWELLBOX STEPS field is displayed:</p> <div style="display: flex; justify-content: space-around; align-items: center;"> <div style="border: 1px solid black; padding: 5px; text-align: center; width: 150px;"> <p>SWELLBOXES STEPS</p> <p>PEDAL: 8</p> <p>MAN I: FULL</p> <p>MAN II: 16</p> <p>MAN III: FULL</p> </div> <div style="border: 1px solid black; padding: 5px; text-align: center; width: 150px;"> <p>SWELLBOXES STEPS</p> <p>PEDAL: 8</p> <p>CHOIR: FULL</p> <p>GREAT: 16</p> <p>SWELL: FULL</p> </div> </div> <p>Settings: 4, 8, 16, Full (continuous control)</p> |
| Crescendo Pedal | <p>[CRESCENDO] pedal operating mode. Settings: On, Off, M.I/PD or M.II/PD or GT/PD Shoe (Man.I/Pedal or Man.II/Pedal or Great/Pedal expression pedal)</p> |
| Link Master Volume Pot. To | <p>Which volume is controlled by the [MASTER VOLUME] potentiometer, placed under the manuals. Settings:</p> <ul style="list-style-type: none"> • Int Gen Vol: internal amplification volume only. • Int+Ext Vol: volume of both the internal amplification and of the signal of the rear outputs [PROG. OUT]. • Ext Vol: volume of the signal of the rear outputs [PROG. OUT] only. • Nothing: no control |
| Orchestra Couplers | <p>Selection of which type of coupler affects the orchestral voices. Settings:</p> <ul style="list-style-type: none"> • None or No: no couplers. • Standard or Yes: only couplings between two manuals, or between manual and pedalboard (though not sub- and super-octave). • All: all kinds of couplers. <p>NOTE <i>None, Standard and All settings are only available for organ models equipped with intra-divisional couplers.</i></p> |

COMBINATIONS SETTINGS (SETUP / COMBINATIONS menu)

The COMBINATIONS menu contains all the settings relating to the combinations available in the organ.

To access to this menu, in the main video page,

1. press the [MENU/ENTER] button,
2. place the cursor on the SETUP field and press [MENU/ENTER],
3. place the cursor on the COMBINATIONS field and press [MENU/ENTER].

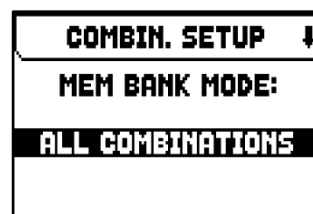

The COMBINATIONS menu contains the following settings:

| Parameter name | Description |
|---|--|
| Mem Bank Mode | Memory Banks operating mode. Settings: <ul style="list-style-type: none"> • All Combinations: all combinations have Memory Banks. • Gen. Combinations: only general combinations have Memory Banks. NOTE <i>This function is only available for organ models equipped with divisional combinations.</i> |
| MIDI Out Controls in Combinations | Enable/disable of storing the status of MIDI tab/thumb pistons in the general and divisional combinations. Settings: No, Yes NOTE <i>This function is only available for organ models equipped with MIDI controls.</i> |
| MIDI Out Controls affected by Cancel | Enable/disable to switch off MIDI tab/thumb pistons by [C] or [CANC] thumb piston. Settings: No, Yes NOTE <i>This function is only available for organ models equipped with MIDI controls.</i> |
| Couplers in Divisional Combinations | Enable/disable of storing the status (and which type) of couplers in the divisional combinations. Settings: <ul style="list-style-type: none"> • None or No: no couplers stored. • Inter-Manual: only couplers (sub and super octave included) between two manuals or manual and pedalboard. • Intra-Manual: only sub and super octave and Unison Off. • All or Yes: all couplings. NOTES <ul style="list-style-type: none"> - <i>This function is only available for organ models equipped with divisional combinations.</i> - <i>None, Inter-Manual, Intra-Manual and All settings are only available for organ models equipped with intra-divisional couplers.</i> |
| Couplers in Crescendo | Enable/disable of storing the status (and which type) of couplers in the Crescendo. Settings: <ul style="list-style-type: none"> • None or No: no couplers stored. • Inter-Manual: only couplers (sub and super octave included) between two manuals or manual and pedalboard. • Intra-Manual: only sub and super octave and Unison Off. • All or Yes: all couplings. NOTE <i>None, Inter-Manual, Intra-Manual and All settings are only available for organ models equipped with intra-divisional couplers.</i> |
| Tremulant parameters in Combinations | Enable/disable of storing the tremulant parameters (see page 18) in the general and divisional combinations. Settings: No, Yes |
| ENC/SWS in Combinations | Enable/disable of storing the status of [ENC] and [SWS] thumb pistons in the general combinations. Settings: No, Yes |
| ENC/SWS affected by Cancel | Enable/disable to switch off [ENC] and [SWS] thumb pistons by [C] or [CANC] thumb piston. Settings: No, Yes |
| A.P. in Combinations | Enable/disable of storing the status of [AUTO PEDAL] or [AUTO PED] thumb piston in the general combinations. Settings: No, Yes |

| | |
|--|--|
| A.P. affected by Cancel | Enable/disable to switch off [AUTO PEDAL] or [AUTO PED] thumb piston by [C] or [CANC] thumb piston. Settings: No, Yes |
| Speakers Switches in Combinations | Enable/disable of storing the status of Internal, External, Main, Antiphonal amplifications switches in the general combinations. Settings: No, Yes |
| PIPES-DIGITAL in Combinations | Enable/disable of storing the status of [P/D], [PIPES] or [DIGITAL] thumb pistons in the general combinations. Settings: No, Yes |
| Orchestra Params in Combinations | Enable/disable of storing the configuration parameters of orchestral voices in the combinations. Settings: No, Yes NOTE <i>This setting affect the parameters that can be adjusted with the function described on page 24 and not with the settings that are stored in the Pipe Sets.</i> |
| TUTTI Mode | Selecting how [TUTTI] combination controls stops. Settings: <ul style="list-style-type: none"> • Gen. Combination: replaces its content. • Layered: adds its content. |

AUDIO SETTINGS (SETUP / AUDIO menu)

The AUDIO menu contains all the audio settings of the organ.

To access to this menu, in the main video page,

1. press the [MENU/ENTER] button,
2. place the cursor on the SETUP field and press [MENU/ENTER],
3. place the cursor on the AUDIO field and press [MENU/ENTER].

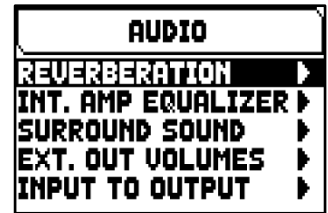

The AUDIO menu contains the following settings:

| Function | Description |
|---|---|
| REVERBERATION | Settings relating the reverb internal effect. |
| INT. AMP EQUALIZER (Internal Amplification Equalizer) | Settings relating the 5-band equalizer of the internal amplifier. |
| SURROUND SOUND | Settings relating the side and front speakers. NOTE <i>This function is only available for organ models equipped with side and front speakers.</i> |
| EXT. OUT VOLUMES (External Out Volumes) | Volumes of the each PROG. OUT output of the rear panel (page 8). |
| INPUT TO OUTPUT | Routing of the input signals present in the AUX IN connectors of the forward panel (page 8) and INPUT of the rear panel, to the PROG. OUT outputs of the rear panel (page 8). |

Adjusting the internal Reverb effect (REVERBERATION function)

Reverberation is the result of a series of sound reflections in a closed environment.

Order and value of each reflection depend on many factors of the environment, such as the size of the room, the number and material of the objects inside the room, the listener's position and so on.

The digital processors of the Physis Plus organs can recreate artificially the complex factors affecting the reverberation of a real pipe organ, generating the right reverberation to complete an already excellent sound quality.

The REVERBERATION function allows to adjust several parameters of the reverb effect.

To access the adjustment screen, select the REVERBERATION field in the AUDIO menu.



The settings which can be made are:

| Parameter name | Description |
|--|---|
| [reverb style] ("Large Cathedral" in the screen shown above) | The simulated environment, and thus the reverberation effect generated. Settings: Large Cathedral, Medium Cathedral, Basilica, Stone Church, Large Chapel, Auditorium, Medium Church, Small Church, Modern Church, Cantoria, Wooden Church, Small Chapel, Conservatory, Studio, Consort. NOTE <i>The number of selectable reverb styles depends on the organ model.</i> |
| D/W Mode (Dry/Wet Mode) | Dry (sound without reverb) and Wet (reverberated sound) signals control mode by the AMOUNT parameter (see below). Settings: <ul style="list-style-type: none"> • Off: the AMOUNT parameter only modifies the amount of Wet signal. • Low, High, Full: the AMOUNT parameter controls, on three scales, the balance between the Wet signal and the Dry signal, and the quantity and quality of acoustic reflections of the environment, simulating an ever deeper and mellow effect. |
| Amount | Level of reverberation. Settings: 0 to 100 |
| Early Reflect. (Early Reflections) | Level of the reverb early reflections. Settings: 0 to 100 |
| Reverb Tail | Level of the reverb tail (time length). Settings: 0 to 100 |

Setting the internal amp equalizer (INT. AMP EQUALIZER function)

The INTERNAL AMPLIFICATION EQUALIZER function adjusts the five-band equalizer of the internal amplification and therefore the sound from the speakers of the organ (not that from the external speakers, which can be adjusted by dedicated equalizers for each PROG. OUT output, available in the “Physis Plus The Editor” application).

To access the adjustment screen, select the INT. AMP EQUALIZER field in the AUDIO menu.

In the lower part of the screen there are the five central band frequencies of the band-pass filters. To move the cursor from one band to the other, use the buttons [^] and [v].

The top of the screen shows the increase or decrease of the signal of the selected band. Each band can be modified from +8 dB (maximum signal gain) to -8 dB (maximum signal dampening). To regulate this use [+] and [-] buttons.

The following graph shows how the equalizer works.

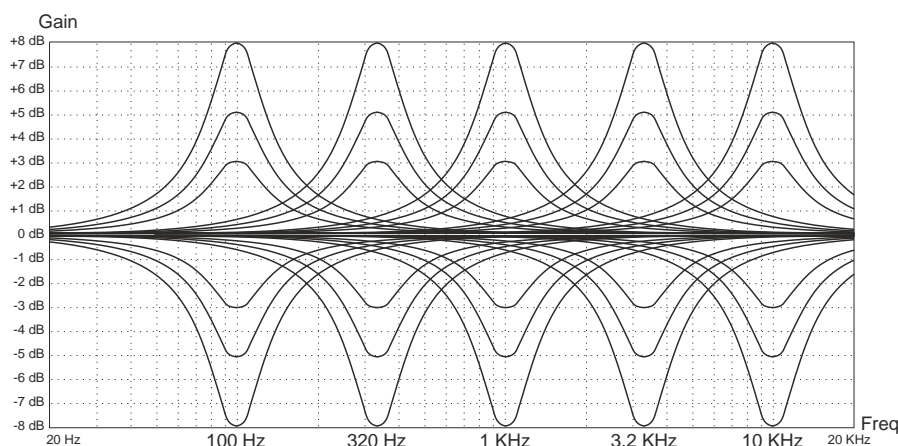
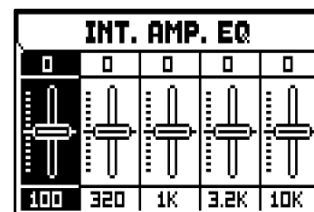

Adjusting the front and side speakers (SURROUND SOUND function)

This function allows to balance the signal levels of the front and side speaker, and to adjust the distribution of the stereo signal spread by side speakers so as to balance the best sound response in case of asymmetric positioning of the organ than the walls of the room in which is located.

To access the adjustment screen, select the SURROUND SOUND field in the AUDIO menu.

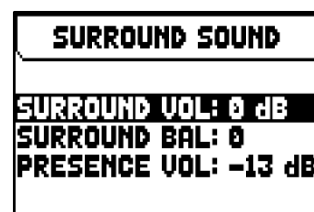

The settings which can be made are:

| Parameter name | Description |
|---|---|
| Surround Vol (Surround Volume) | Volume of the side speakers expands the sound stage, giving the feeling of being in a bigger environment. Settings: Off, -59 dB to 0 dB |
| Surround Bal (Surround Balance) | Stereophonic balance of the side speakers. Settings: 63L to 63R |
| Presence Vol (Presence Volume) | Volume of the front side speakers makes the sound more natural and detailed, emphasizing on the dynamic evolution of the pipes sound. Settings: Off, -59 dB to 0 dB |

Regulating the volume of the PROG. OUT rear outputs (EXT. OUT VOLUMES function)

The external sound configuration can be customized further by regulating the volume of each PROG. OUT rear outputs.

To access the adjustment screen, select the EXT. OUT VOLUMES field in the AUDIO menu.

In the lower part of the screen there are the number of the output. To move the cursor from one output to the other, use the buttons [^] and [v].

The top of the screen shows the signal level of the selected output. Each volume can be modified from -18 dB to +6 dB. To regulate this use [+] and [-] buttons.

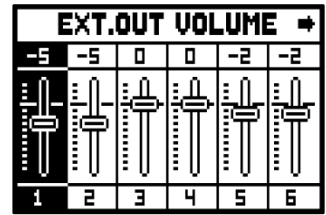

Routing of the audio inputs to the outputs (INPUT TO OUTPUT function)

This function allows to set the routing of the input signals present in the AUX IN (underneath the manuals) and INPUT (on the rear panel) connectors to the PROG. OUT outputs of the rear panel.

To access the adjustment screen, select the INPUT TO OUTPUT field in the AUDIO menu.

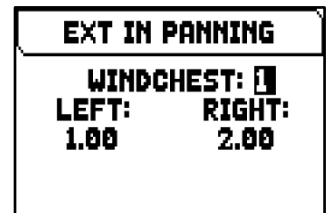

The settings which can be made are:

| Parameter name | Description |
|------------------|--|
| Windchest | It is possible to set 2 type of routing. Here select which you are setting. Settings: 1, 2 |
| Left | PROG. OUT output where the left input signal is routed. Settings: [output number] |
| Right | PROG. OUT output where the right input signal is routed. Settings: [output number] |

MIDI SETTINGS (SETUP / MIDI menu)

The MIDI menu contains all the settings of the organ's MIDI interface.

To access to this menu, in the main video page,

1. press the [MENU/ENTER] button,
2. place the cursor on the SETUP field and press [MENU/ENTER],
3. place the cursor on the MIDI (2nd page) field and press [MENU/ENTER].



The MIDI menu contains the following settings:

| Function | Description |
|--|--|
| TX/RX Channels | Selection of input and output MIDI A and B channels for each organ section. |
| TX/RX Filters | Enable/disable of input and output MIDI filters. |
| PRG in Combin. (Program Change in Combinations) | Store of Program Change and Bank Select MIDI messages in combinations. |
| Coupled  Out | <p>Enable/disable the transmission of MIDI notes generated by couplers.</p> <p>Settings:</p> <ul style="list-style-type: none"> • None or No: no couplers. • Standard or Yes: only couplings between two manuals, or between manual and pedalboard (though not sub- and super-octave). • All: all kinds of couplers. <p>NOTE <i>None, Standard and All settings are only available for organ models equipped with intra-divisional couplers.</i></p> |

NOTE

For further informations about the MIDI interface of the Physis Plus organs, see page 58.

Selecting the input and output channels (TX/RX CHANNELS function)

The organ can send out MIDI messages on a single channel, or through two channels simultaneously. It can only receive on one channel.

To the MIDI channels, select the TX/RX CHANNELS field in the MIDI menu.

| SECTION | Tx A/B | Rx |
|---------|--------|----|
| PEDAL | 4 / - | 4 |
| MAN I | 3 / - | 3 |
| MAN II | 2 / - | 2 |
| MAN III | 1 / - | 1 |

| SECTION | Tx A/B | Rx |
|---------|--------|----|
| PEDAL | 4 / - | 4 |
| CHOIR | 3 / - | 3 |
| GREAT | 2 / - | 2 |
| SWELL | 1 / - | 1 |

The settings which can be made are:

| Parameter name (displayed at the top of the column) | Description |
|--|---|
| Section | Organ division for which to set MIDI channels. Settings: [organ division] |
| Tx A/B | Transmission (output) A and B MIDI channels. Settings: - (no transmission), 1 to 16 |
| Rx | Receiving (input) MIDI channel. Settings: - (no reception), 1 to 16 |

Setting the input and output filters (MIDI FILTERS function)

A MIDI filter allows to block a particular message on all MIDI channels (if the signal is channelled). The CC transmission filter, for example, blocks Control Change MIDI messages in the [MIDI OUT] port, on all MIDI channels of the organ. In the same way, the PG receiving filter blocks Program Change on all channels (therefore they are not executed to recalling combinations, Tutti, Crescendo) received from the [MIDI IN] port.

To the MIDI filters, select the TX/RX FILTERS field in the MIDI menu.

| MESSAGE | Tx | Rx |
|----------|-----|-----|
| CC | NO | NO |
| PG | NO | NO |
| SysEx | NO | NO |
| RealTime | YES | YES |

The settings which can be made are:

| Parameter name (displayed at the top of the column) | Description |
|--|--|
| Message | MIDI messages to filter. Settings: <ul style="list-style-type: none"> • CC: Control Change • PG: Program Change • SysEx: System Exclusive • RealTime: Real Time |
| Tx | Enable/disable transmission (output) filter. Settings: No, Yes |
| Rx | Enable/disable receiving (input) filter. Settings: No, Yes |

Saving Program Change messages in the combinations (PRG IN COMBIN. function)

Program Change MIDI messages can recall, in a connected unit, a particular sound or program (patch). Thanks to this function you may select a desired voice from external module (such as an expander) connected to the [MIDI OUT] port.

You can also transmit Bank Select messages MSB (CC n. 0) and LSB (CC n.20) to select program banks from an external source.

Please note that the MIDI messages of this screen are immediately sent to the corresponding section, and also saved in the general and divisional combination and Tutti. To do so, select the Program Change and Bank Select and fix the desired memory. This process might prove useful when, using an external expander, you wish to combine a voice from this unit with other stops.

To the MIDI filters, select the TX/RX FILTERS field in the MIDI menu.

| MIDI A | PG | MSB | LSB |
|---------|-----|-----|-----|
| PEDAL | --- | 0 | 0 |
| MAN I | 8 | 0 | 0 |
| MAN II | --- | 0 | 0 |
| MAN III | 31 | 4 | 1 |

| MIDI A | PG | MSB | LSB |
|--------|-----|-----|-----|
| PEDAL | --- | 0 | 0 |
| CHOIR | 8 | 0 | 0 |
| GREAT | --- | 0 | 0 |
| SWELL | 31 | 4 | 1 |

The settings which can be made are:

| Parameter name (displayed at the top of the column) | Description |
|---|---|
| [MIDI channel] ("MIDI A" in the screen shown above) | MIDI channel A or B of each organ division to transmit on. Settings: MIDI A, MIDI B |
| PG | Program Change to transmit. Settings: - - - (no transmission), 1 to 128 NOTE <i>Selecting "- - -", Bank Select MSB and LSB messages are not transmitted.</i> |
| MSB | Bank Select MSB to transmit. Settings: 0 to 127 |
| LSB | Bank Select LSB to transmit. Settings: 0 to 127 |

BACKUP, RESTORE and FACTORY RESET of ORGAN CONFIGURATION (BACKUP/RESTORE menu)

The BACKUP/RESTORE menu contains functions to backup (save as .all file) the entire organ configurations (Pipe Sets, combinations, settings) in a USB flash drive, reload it (or parts of it) into the internal memory and reset to the factory-set state of the entire organ settings. Created backup files are also called “Snapshot”.

To access to this menu, in the main video page,

1. press the [MENU/ENTER] button,
2. place the cursor on the BACKUP/RESTORE (2nd page) field and press [MENU/ENTER].



The BACKUP/RESTORE menu contains the following settings:

| Function | Description |
|-----------------------------|--|
| Save Snapshot | Save of the entire organ configuration (Pipe Sets, combinations, settings) in a USB flash drive. |
| Load Snapshot | Load the entire organ configuration or single sections (Pipe Sets, combinations, settings) from a USB flash drive. |
| Factory Reset | Restore of the entire organ configuration (Pipe Sets, combinations, settings) to the factory-set state. |
| Restore Def. Setting | Restore the instruments settings to the factory-set state. |

NOTES

- Once the USB flash drive is inserted please wait some seconds before displaying the BACKUP/RESTORE menu. If the instrument still does not detect the drive, showing “Warning: no USB mem” on the bottom of the screen, press [EXIT] to leave the menu and then try again.
- When connecting a new or just formatted USB flash drive to the organ, the system will automatically create two directories in the drive: “v_settings” and “v_songs”. The system needs these two folders to arrange files, and they must not be deleted or renamed, otherwise the saved files will be lost. The system will save the organ configuration as .ALL file in the “v_settings” directory. Please pay attention not to delete or rename this folder to avoid losing or making unusable the recordings.
- Always use USB flash drive formatted with FAT or FAT32 file system (no NTFS).

What a Snapshot contains

Below is the complete list of what a Snapshot contains:

| Section | Parameter | Display page | Explanation page |
|---------------------|--|---|--------------------|
| Pipe Sets | All the parameters contained in all the Pipe Sets available in the instrument. | | 11 |
| Pipe Sets | Stop list. | available in the “Physis Plus The Editor” application | |
| Combinations | All the combinations of all the Combination Sets available in the instrument. | | 13 |
| Combinations | Combinations parameters | SETUP / COMBINATIONS | 31 |
| Settings | Surround, Presence, Balance, External Volume, External Reverb parameters | LEVELS | 16 |
| Settings | Piston Combine parameters | SETUP / KEYBOARDS | 26 |
| Settings | Organ Solo parameters | SETUP / KEYBOARDS / ORGAN SOLO | 29 |
| Settings | A.P. Mode | SETUP / KEYBOARDS | 26 |
| Settings | ENC / SWS Config | SETUP / CONTROLS | 30 |
| Settings | Swellboxes Steps | SETUP / CONTROLS | 30 |
| Settings | Link Master Volume Pot. To | SETUP / CONTROLS | 30 |
| Settings | Orchestra Couplers | SETUP / CONTROLS | 30 |
| Settings | Audio parameters (except Reverberation parameters) | SETUP / AUDIO | 33 |
| Settings | MIDI parameters | SETUP / MIDI | 36 |

| | | | |
|----------|-----------------------------|---|----|
| Settings | LCD Contrast | UTILITY | 41 |
| Settings | Auto Mainpage | UTILITY | 41 |
| Settings | Sub Loud | Available in the "Physis Plus The Editor" application | |
| Settings | External outputs parameters | Available in the "Physis Plus The Editor" application | |

Save the organ configuration in a USB flash drive (SAVE SNAPSHOT function)

To save the entire organ configuration (Pipe Sets, combinations, settings) in a USB flash drive as a .ALL file, follow this procedure:

1. insert a USB flash drive in the left USB connector underneath the manuals,
2. in the main video page press the [MENU/ENTER] button,
3. select the BACKUP/RESTORE field,
4. select the SAVE SNAPSHOT field,
5. assign a name to the file that will be saved in the USB flash drive. The system proposes a name as "SNAP" and the date actually setted in the organ (see page X), to modify it use the [^] and [v] buttons to move the cursor, [+] and [-] to select the character.
6. press [MENU/ENTER] to save (or [EXIT] to quit) and wait the "FILE SAVED" message. A .ALL file will be saved in the "v_settings" folder of the USB flash drive.



Load an organ configuration from a USB flash drive (LOAD SNAPSHOT function)

To load an entire organ configuration or single sections (Pipe Sets, combinations, settings) from a USB flash drive saved as a .ALL file using the SAVE SNAPSHOT function (see above), follow this procedure:

1. insert the USB flash drive with the .ALL file(s) in the left USB connector underneath the manuals,
2. in the main video page press the [MENU/ENTER] button,
3. select the BACKUP/RESTORE field,
4. select the LOAD SNAPSHOT field,
5. select the .ALL file of the organ configuration you want to load and press the [MENU/ENTER] button,
6. select what you want to load of the .ALL file into the organ:
 - **Entire Snapshot:** the entire organ configuration
 - **Only Combinations:** all the combinations of the all Combinations Set
 - **Only Pipe Sets:** all the Pipe Sets
 - **Only Settings:** all the organ settings



Refer to the table above in "What a Snapshot contains" to know in detail what a Snapshot section contains.

7. press [MENU/ENTER] button to confirm the load and wait the reboot of the organ (if ENTIRE SNAPSHOT, ONLY COMBINATIONS or ONLY PIPESETS option was selected) or the "SNAPSHOT RESTORED" message, or [EXIT] to quit.

NOTES

- Please pay very close attention when loading a Snapshot, because the actual configuration of your organ will be irreparably lost. To avoid this, before load a .ALL file, save the actual organ configuration in USB flash drive using the SAVE SNAPSHOT function and, if necessary, reload it using the LOAD SNAPSHOT function (see above).
- Loading a .ALL file (using the Entire Snapshot or Only Pipesets options) containing a different stop list, the display will show the message "DIFFERENT STOP LIST FOUND. REPLEACE PIPESETS ANYWAY?", remembering you that one or more stop label will not match with the played voice (and so possibly you will have to move the labels). Press [MENU/ENTER] to confirm the load or [EXIT] to quit.
- It is not possible to load a .ALL file created with a different organ model. In this case the display will show the message "DIFFERENT ORGAN MODEL LOAD ABORTED".
- If one or more Combinations Sets are protected by PIN, loading a .ALL file the display will show the message "OVERWRITING PIN-PROTECTED COMBINATIONS ARE YOU SURE?". Press [MENU/ENTER] to confirm the load or [EXIT] to quit.
- If you wish to rename .ALL files saved to the USB stick using a computer, always make sure that the names names can be a maximum of 12 characters and cannot contain special characters such as "_", "@", "#", etc.

Restore the factory organ configuration (FACTORY RESET function)

To restore the **entire** organ configuration (Pipe Sets, combinations, settings) to the factory conditions, follow this procedure:

1. in the main video page press the [MENU/ENTER] button,
2. select the BACKUP/RESTORE field,
3. select the FACTORY RESET field,
4. at the message "RESTORING TO FACTORY STATUS, PROCEED?" press [MENU/ENTER] to confirm or [EXIT] to abort.



Restore the default settings (RESTORE DEF. SETTING function)

It is possible to restore only the Settings of the organ configuration to the factory conditions (refer to the table in "What a Snapshot contains" to know in detail what contains the Settings section). To do so, follow this procedure:

1. in the main video page press the [MENU/ENTER] button,
2. select the BACKUP/RESTORE field,
3. select the RESTORE DEF. SETTING field,
4. at the messages "REVERTING TO DEFAULT, PROCEED?" and "RESTORING STOP LIST, PIPE SETS, COMBINATIONS AND SETTINGS, ARE YOU SURE?" press [MENU/ENTER] to confirm or [EXIT] to abort.

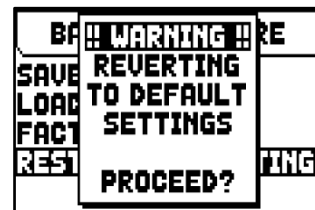

UTILITIES FUNCTIONS (UTILITY menu)

The UTILITY menu contains general functions like informations concerning the organ model, update of the operating system, lock of some functionality of the organ, expression pedals calibration and others.

To access to this menu, in the main video page,

1. press the [MENU/ENTER] button,
2. place the cursor on the UTILITY (2nd page) field and press [MENU/ENTER],

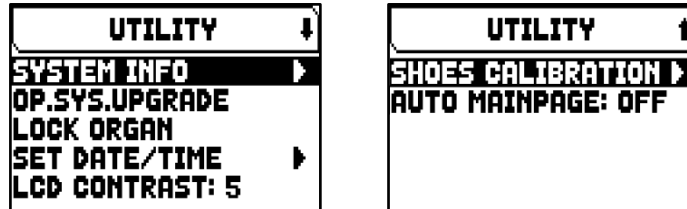

The UTILITY menu contains the following settings:

| Function | Description |
|--------------------------|--|
| System Info | Displays the organ model, the version of the firmware installed in the instrument, information on the internal amplifiers. |
| Op.Sys Upgrade | Upgrade of the instrument's operating system. |
| Lock Organ | Set a code to lock out the modifying / saving of instrument settings, combinations and song recording. |
| Set Date/Time | Internal date and time setting. Press [MENU/ENTER] to access the setting page. |
| LCD Contrast | Display contrast adjustment. Settings: 0 to 15 |
| Shoes Calibration | Expression pedals calibration. |
| Auto Mainpage | Automatic return to the main video page if no display functions are used for 10 seconds. Settings: Off, On |

Upgrading the operating system (OP. SYS. UPGRADE function)

Each time an update file is released it will be made available on the website <http://www.viscountinstruments.com>. Update files are named upgrade-X.X.X. PHX, where X.X.X stands for the update version.

To check the currently running operating system version, access the SYSTEM INFO page.

To update the operating system, follow this procedure:

1. after the .ZIP file has been downloaded, extract the .PHX file and copy it to the main folder (root) of a USB flash drive,
2. insert the USB flash drive with the .PHX file in the left USB connector underneath the manuals,
3. in this phase the system checks the upgrade installation files in your flash drive, so please wait some seconds,
4. in the main video page press the [MENU/ENTER] button,
5. select the UTILITY field,
6. select the OP.SYS.UPGRADE field,
7. now a pop-up (similar the one illustrated on the right) shows you the operating system version found on the USB flash drive and the one installed in the instrument. If you are sure about the new version, press [MENU/ENTER] to proceed with the upgrade or [EXIT] to abort.
8. If the version on your flash drive is same or older than the one already installed in your organ, the system will inform you with a message "OS.SYS REPLACE WITH SAME OR OLDER VERSION, ARE YOU SURE?". Also in this case, press [MENU/ENTER] to proceed with the upgrade or [EXIT] to abort.
9. Once the update is confirmed, the display will show the messages concerning the phases of the update. When the update is complete the display shows the message "DONE PLEASE SWITCH OFF THE ORGAN."
10. Switch off and on the instrument.



IMPORTANT NOTES!

- Once the USB flash drive is inserted please wait some seconds before starting the upgrade. If the instrument still does not detect the drive, showing "USB pen not found" message, press [EXIT] to leave the upgrade and then try again. For the same reason, the system may not have completed checking the .PHX file yet. Again press [EXIT] to leave the upgrade and then try again.
- Pay attention when copying the .PHX file in your USB flash drive. The file must always be placed in the main directory of the drive and not inside any other folder (the address of the main directory usually appears as D:\ or F:\, not D:\Peter or F:\v_songs; "Peter" and "v_songs" are subfolders and .PHX file should not be saved inside these). If the file is not placed correctly, the instrument will not recognize it and will not be able to install the update.
- Pay attention to save the .PHX file in your USB flash drive, and not the .ZIP file. Furthermore, in the main directory of the USB drive there shouldn't be any other .PHX files.
- Do NOT switch off the instrument or disconnect the USB drive while updating the system.
- Always use USB flash drive formatted with FAT or FAT32 file system (no NTFS).
- It is strongly recommended to use USB flash drives containing only one partition. If USB flash contains two or more partitions (even if hidden), copy the update file to the first partition. By copying the update file to other partitions, this is not detected by the instrument, displaying the error message "Update file not detected".
- The first time the organ is switched on after an update, the instrument will take longer than usual to start working, also sound modules could be updated, by displaying this phase, due to the necessary reconfiguration of the system.

Controlling the access to the organ settings (LOCK ORGAN function)

When necessary, organ settings can be locked, so that only authorized users can access them. The LOCK ORGAN function is designed just for this purpose. When active, combinations, Tutti, Crescendo steps, and/or organ settings, cannot be modified. The Record function of the sequencer can also be locked, so that recorded songs cannot be edited.

To recall this function, follow this procedure:

1. in the main video page press the [MENU/ENTER] button,
2. select the UTILITY field,
3. select the LOCK ORGAN field,
4. select which sections will be locked:
 - **Cmb Banks:**
 - locking the modification of all the combinations of all Combinations Sets of the first memory bank (selecting **1st**) or of all the banks (selecting **Yes**), Tutti, Plenum and Crescendo.
 - locking of Copy, Rename, Clear, Insert PIN and Import of Combinations Sets.
 - locking of combinations settings and loading of combinations from a Snapshot.
 - **User Paramars:**
 - locking of Copy/Rename/Restore Default of Pipe Sets
 - locking of Voicing
 - locking of Keyboards settings (except Keyboards Inversion and Piston Combine)
 - locking of Controls settings (except ENC/SWS Config and Master Volume pot. Link)
 - locking of Audio settings (except Reverb Dry/Wet Mode and Amount)
 - locking of MIDI settings (except setting of Program Change in Combinations)
 - locking of Load Snapshots (except Only Combinations)
 - locking of Factory Reset and Restore Default Settings
 - locking of Utility functions (except LCD Contrast).
 - **Seq Record:** locks the sequencer's Record function.
5. press [MENU/ENTER] to set a password. Use the [^] and [v] buttons to move the cursor, [+] and [-] to select the character.
6. press [MENU/ENTER] to save the code or [EXIT] to abort.

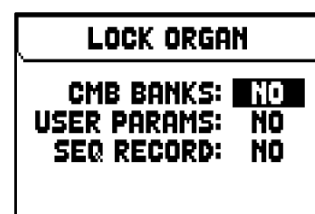

To unlock the organ, select the UNLOCK ORGAN field in the UTILITY menu and set the right password using the buttons described above. If the password is correct, the message "ORGAN UNLOCKED" will be displayed.

Pedals calibration (SHOES CALIBRATION function)

Whenever a new CPU is installed in an organ, or when one or more pedals are replaced, it could be necessary to calibrate pedals.

To recall the calibration function, follow this procedure:

1. in the main video page press the [MENU/ENTER] button,
2. select the UTILITY field,
3. select the SHOES CALIBRATION field,
4. in the calibration screen the following fields are displayed:
 - **[pedal name] Acquired:** name and value of the pedal currently under calibration.
 - **Actual Max:** maximum value stored in memory.
 - **Actual Min:** minimum value stored in memory.

ACTUAL MIN and ACTUAL MAX will be shown only when the pedal is, respectively, either at minimum or maximum position.
5. set an expression pedal or the Crescendo into maximum or minimum position and press [MENU/ENTER],
6. place the pedal in the opposite position (from maximum to minimum or vice versa) and press [MENU/ENTER].
7. Perform this operation on all available pedals. When the operation is complete, press [EXIT] to store the calibration.

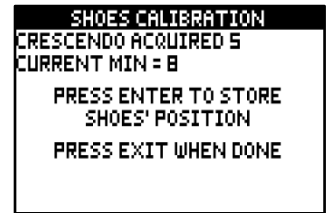

NOTE

The system stores the MIN and MAX values slightly higher and lower than those actually read. This is done to ensure that the minimum and maximum position is always reached.

PLAYING AND RECORDING OF MUSICAL SEQUENCES (SEQUENCER)

The Physis Plus organs are equipped with an internal sequencer (digital recorder) capable of recording performances on the instrument, the commands and controls used and MIDI data received through the MIDI [IN] port. Recordings can then be saved on the USB stick or in the internal memory as MIDI files (Standard MIDI file, format 1 to 125 beats per minute, 384 ticks per quarter note) and played back at any time. Song lists can also be played.

To recall the sequencer press the [SONG] button beside the display. The screen for selection of the sequencer functions is displayed.



| Mode | Description |
|--------------|--|
| PLAY | Playing back of the songs or song lists saved in the internal memory or the USB flash drive. |
| PLAY OPTIONS | Options for playing back songs. |
| RECORD | Recording of performances. |
| SONG LIST | Programming of lists of songs. |

The memory unit currently used appears in the bottom of the screen. Remember that the USB stick has priority over the internal memory; to use the latter, first remove the USB stick.

NOTES

- Once the USB flash drive is inserted please wait some seconds before recalling the sequencer. In case of failed recognition, press [EXIT] to leave the sequencer, then re-enter
- If using a USB flash drive, remember to format it with FAT or FAT32 (no NTFS) file system.
- If using a USB flash drive, the system will use and save the recordings as .MID file in the "v_songs" directory. Please pay attention not to delete or rename this folder to avoid losing or making unusable the recordings.
- Transposition set in the TUNING menu does not have any effect on playback of songs (unlike recording, where the notes are acquired transposed). To do this you have to set the transposer described at page 48.

Playing back a song or a song list (PLAY mode)

In the sequencer mode selection screen described above, select the PLAY field. The display shows the MIDI files stored in the memory unit currently in use. Now select the .MID file (single song) or .LST file (song list) you wish to play back. The new screen provides information about all the controls necessary for use of the sequencer:

- [MENU/ENTER]: starts playback of the song.
- [EXIT]: quits the sequencer.
- [^]: selects the previous song saved in the memory or from a song list.
- [v]: selects the next song saved in the memory or from a song list.
- [-] (press once): slow down play speed. It can be seen on top left as percentage (BPM=100 in the picture on the right).
- [+] (press once): increase play speed. It can be seen on top left as percentage (BPM=100 in the picture on the right).
- [-] (press and hold): rewind.
- [+] (press and hold): fast forward.



Once the playback of a song has been started, the display changes, the functions of the [MENU/ENTER] and [EXIT] buttons have changed to:

- [MENU/ENTER]: pause /restart playback of the piece.
- [EXIT]: stop playback of the piece.

[^], [v], [-], [+] keep the functions already described.

Using recorded and/or modified songs with dedicated software

MIDI files recorded by the internal sequencer can be modified with the most common MIDI editing softwares. This might prove useful to correct errors of the recording or to generally improve the track. However, we strongly advice inexperienced users not to do so. When modifying a MIDI file, please follow these rules:

- Do not modify the tracks channel. If it necessary, respect the internal sequencer channelling. The sections are channelled as follows:
 - Pedal: 1
 - Man.I (3-manual models) or Choir: 4
 - Man.II (3-manual models), Man.I (2-manual models) or Great: 2
 - Man.III (3-manual models), Man.II (2-manual models) or Swell: 3
 - Man.IV or Solo (4-manual models): 5
- The internal sequencer also assigns a name to the track while recording, that corresponds to the sections playing a track. Most computer software can read the track names:
 - "Pedal" track: Pedalboard
 - "Choir" track: Man.I (3-manual models) or Choir notes
 - "Great" track: Man.II (3-manual models), Man.I (2-manual models) or Great notes
 - "Swell" track: Man.III (3-manual models), Man.II (2-manual models) or Swell notes
 - "Solo" track: Man.IV or Solo (4-manual models) notes
 - "Volumes" track: divisional volumes and expression pedals
 - "Stops" track: stops conditions

There are other tracks for internal use and future developments only, that should not be altered.

- Divisional volumes are recorded as Control Change 7 events. Expression pedals position as Control Change 11. These Control Change channel are identical to the previous ones.
- The stops settings, together with cancel, enclosed, coupling settings etc. are recorded as System Exclusive messages. We advice you not to alter these codes. If you wish to add or remove stops from a recording, you should know its exclusive system code. To do so, you should monitor the MIDI OUT port of the organ and, switching on and off a stop, check the MIDI code transmitted. Add or remove this code only from the "stops" track.
- When saving the MIDI file do not change the resolution of 384 tpqn (tick per quarter note).

The sequencer can also paly non-recorded tracks. Again, keep in mind that:

- The track channelling may not be consistent with the internal sequencer. Reset the channels according to what described above.
- Stop codes might not be present in a MIDI track. In this case we advice you overdub (see page 46) with the desired stop combination.
- Divisional volumes and expression pedals may be lacking from a MIDI track. Again, we advice you overdub the tracks.

Recording a song (RECORD mode)

In the sequencer mode video page, select the RECORD field. The display will show the file list.

Select [NEW SONG] to start a new recording. Otherwise, a MIDI file can be loaded to overdub it, or in other words make a new recording which will be added to the performance already recorded.

At the bottom of the screen screen again are displayed the functions of the buttons:

- [MENU/ENTER]: starts the recording.
- [EXIT]: quits the sequencer function.

Once recording has started, the functions change to:

- [MENU/ENTER]: pause/restart recording.
- [EXIT]: stop recording.

Press [EXIT] to end the session. The display will show the screen allowing the recording just made to be saved.

The functions displayed allow:

- **Save:** saving of the recording as a MIDI file.
- **Play:** playback of the recoding before saving it.



- **Overdub:** creation of a new recording to be added to the sequence just acquired.
- **Discard and Exit:** delete the recording and quit sequencer Record mode.

If the SAVE field is selected, the system prompts the user to assign a name to the MIDI sequence about to be saved. When composing the name, use the [^] and [v] buttons to move the cursor and [+] and [-] to select the character. The first three characters can only be numbers, since they are required for future expansions of the instrument.

To confirm the name and proceed to save the data, press the [MENU/ENTER] button; use [EXIT] to return to the previous screen, aborting the saving operation.

The "SONG SAVED" message confirms that the recording has been saved.

If [EXIT] is pressed while in the save screen (i.e. when the recording has been acquired but not saved), the system warns that the recording is about to be lost with the message "DISCARD SEQUENCE TAKE?" and that [MENU/ENTER] must be pressed to confirm that you wish to quit and delete the data acquired, or [EXIT] to return to the save screen.

NOTE

If you wish to rename .MID files saved to the USB stick using a computer, always make sure that the names can be a maximum of 12 characters (including those before the "_") and cannot contain special characters such as "_", "@", "#", etc. In add of this please pay attention to do not delete the first three characters and the "_".

Overdubbing a song (OVERDUB mode)

The internal sequencer record, play, but also overdub already recorded MIDI tracks. It can be done:

- selecting a MIDI file from the current memory unit, from the RECORD function;
- at the end of a recording session, accessing the OVERDUB function.

The system will ask whether to substitute the settings (stops, coupling, tremulant, MIDI controls, general controls) recorded in the track with the ones currently selected. Then the system will ask the same question, this time regarding the divisional volumes and expression pedals.



In both cases, press [MENU ENTER] to use the new settings or [EXIT] to leave them as they are.

Now the sequencer is ready to overdub. The screen carries information about the functions of the buttons:

- [MENU/ENTER]: starts recording.
- [EXIT]: quits the sequencer.
- [-] (press once): slow down play / recording speed. It can be seen on top left as percentage (BPM=100 in the picture on the right).
- [+] (press once): increase play / recording speed. It can be seen on top left as percentage (BPM=100 in the picture on the right).
- [-] (press and hold): rewind.
- [+] (press and hold): fast forward.



As the recording begins, the controls change again:

- [MENU/ENTER]: pause / re-start recording.
- [EXIT]: stop recording.

[+] and [-] maintain the functions described above.

Note that when the original piece ends, the overdubbing does not stop. To warn you of this, the advancement bar changes as showed by the screen at right.

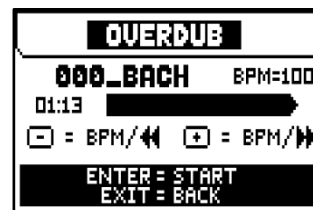

NOTES

- When overdubbing tracks with changing tempo, it is impossible to rewind or Fast Forward while recording. However, it can be done when paused.
- After the overdubbing has been started, it is impossible to change the play speed. However, it can be done when paused or stopped.

To stop and quit the recording press [EXIT], the system will ask you to accept the overdubbing. You can choose one of the following options:

- **Accept:** accept the overdubbing. In case the overdub track is shorter than the original piece, it will not be shortened.
- **Trim and Accept:** accept the overdubbing. If the overdub track is shorter than the original piece, this will be trimmed to end together with the overdubbing.
- **Play:** play the piece with the overdubbing, so as to assess the track. The changes will not be saved yet.
- **Play from last Ovd (overdub):** plays the piece, starting from the first event of last overdubbing, so as to assess the track. The changes will not be saved yet.
- **Discard:** discards the overdubbing.

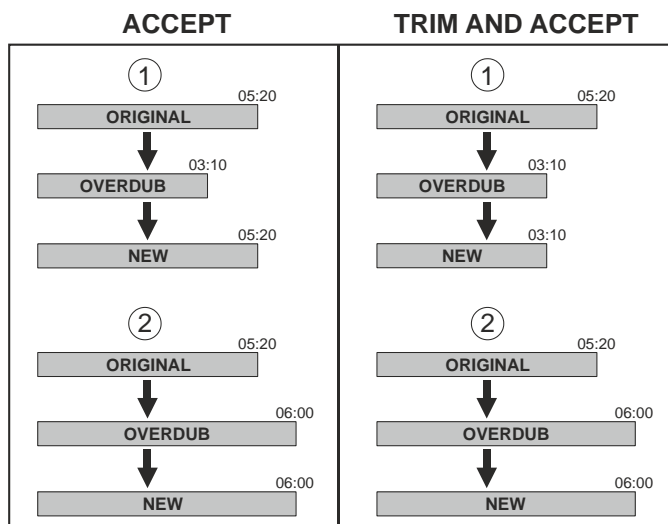
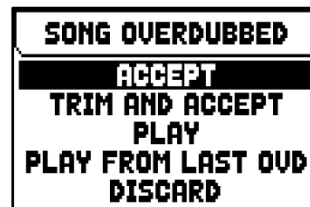

Selecting ACCEPT or TRIM AND ACCEPT the saving screen will be displayed. Now it is possible to save the song with a different name.

Selecting PLAY or PLAY FROM LAST OVD will activate the sequencer play mode.

Press [EXIT] to quit the screen. The display will show the message “DISCARD SEQUENCE TAKE?”, warning you that the overdubbing will be lost. Press [MENU/ENTER] to continue – and therefore discard the recording – or [EXIT] to return to the previous screen.

Creating lists of songs (SONG LIST function)

The function SONG LIST is used to create and save lists of music pieces (MIDI files).

To program a list of songs, select the SONG LIST function in the SEQUENCER menu; the system asks whether you wish to create a new one or modify an existing one.

Select the [NEW LIST] field to create a new list, or select an .LST file to modify the list it contains.

In both cases, to create / edit a list follow this procedure:

1. the first operation is to select the song you wish to include in the list. Use the [^] and [v] buttons to select the MIDI file, [+] to add it to the list and [-] to remove it. Its position within the list appears beside the name of the file.
2. now press [MENU/ENTER] to continue the programming or [EXIT] to abort, in this case the system requests a confirm to proceed with the quit showing the message “DISCARD SONG LIST?”.



3. arrange the songs within the list (or confirm the previous programming). To move a piece into a different position, locate the cursor on the relative field of the file with the [^] and [v] buttons and use [+] to move the position forward or [-] to set an earlier position.
4. press [MENU/ENTER] to save the list or [EXIT] to return to the previous video page.
5. as for MIDI files, the first three characters can only be numbers. To enter the name, use [^] and [v] buttons to move the cursor and [+] and [-] to select the character.
6. press [MENU/ENTER] to confirm the name and proceed to save, or [EXIT] to return to the previous video page. The "FILE SAVED" message confirms that the LIST has been saved. If [EXIT] is pressed while in the save screen (i.e. when the recording has been acquired but not saved), the system warns that the recording is about to be lost with the message "DISCARD SONG LIST?" and that [MENU/ENTER] must be pressed to confirm that you wish to quit and delete the data acquired, or [EXIT] to return to the save screen.

NOTE

If you wish to rename .LST files saved to the USB flash drive using a computer, always make sure that the names can be a maximum of 12 characters (including those before the "_") and cannot contain special characters such as "_", "@", "#", etc. In add of this please pay attention to do not delete the first three characters and the "_".

Play options of the sequencer (PLAY OPTIONS menu)

Select the PLAY OPTIONS field to access the menu offering the following options:

| Function | Description |
|----------------------|---|
| Transposer | Setting a semitone transposition on the songs played by the sequencer. |
| Song Loop | Select ON to automatically loop any song. |
| List Autoplay | Select ON to automatically play the next song when the previous is over, without pressing the [v] button. Only works with song lists. |
| List Loop | Select ON to automatically loop a song list. |

APPENDIX

Stop Local Off

Setting a stop in Local Off mode means that it will not be played by the organ's internal sound generation system, but the relative MIDI (System Exclusive code) message will be transmitted, so that it can be turned on and played on a connected instrument.

To set a stop in Local Off mode, while the main screen is on the display, press the [S] or [SET] thumb piston, keep it pressed and also press the [C] or [CANC] thumb button. The Leds of all the stops will light up and the display will show a pop-up.

To set a voice in Local Off mode, operate its draw-stop or rocker switch so that its light goes out.

After setting the setup required, press [S] or [SET] and [C] or [CANC] together to save it.

Accessing the Local Off setting function after this will trigger display of the status of the stops as follows:

- Light on: stop in Local On mode (plays with internal generation)
- Light off: stop in Local Off mode



On-screen error and info messages

| Message | Description |
|---|---|
| Filesystem error | Reading error of the current memory unit. If this occurs with a USB flash drive, try disconnecting and then connecting it again shortly thereafter. If this doesn't work, try formatting the flash drive using a computer. If this occurs with the internal memory, try again or contact the technical support at the e-mail address <i>service@viscount</i> . |
| No files found | There are no files of that type in the current memory. |
| USB pen not found No USB pen attached | The system does not detect the USB flash drive that is necessary for the current operation. If the correct USB flash drive is connected to the instrument, disconnect it then connect it again. Also check that the flash drive is formatted correctly with the FAT32 file system and that it is undamaged. |
| File load failed Can't open file | The system failed to load the .CMB file, the desired file could not be opened. The file system in the USB flash drive could be corrupted. Try to re-copy the file in the USB flash drive or to format it. |
| File load failed Can't read file's header | The system failed to load the .CMB file, its header is impossible to read. The file system in the USB flash drive could be corrupted. Try to re-copy the file in the USB flash drive or to format it. |
| File load failed File's length check failed | The .CMB file load failed because the actual file length is different from what stated in the header. The file system in the USB flash drive could be corrupted. Try to re-copy the file in the USB flash drive or to format it. |
| File load failed Invalid version number | .CMB file load failed because the file has been generated with a newer and/or not compatible release of the operating system. |
| File load failed Invalid file's checksum | The system could not load the .CMB file. The checksum test failed. The file or file system in the USB flash drive could be corrupted. Try to re-copy the file in the USB flash drive or to format it. |
| Error Snapshot file is corrupted | The system could not load the .ALL file. The file or file system in the USB flash drive could be corrupted. Try to re-copy the file in the USB flash drive or to format it. |
| Error Different organ model | The system could not load the .ALL file because it has been created with a different organ model. It is not possible to load a .ALL file created with a different organ model. |
| Error Invalid file version | .ALL file load failed because the file has been generated with a newer and/or not compatible release of the operating system. |
| Different stop list found. Replace pipe sets anyway? | You are loading a .ALL file (using the Entire Snapshot or Only Pipesets options) containing a different stop list, one or more stop label will not match with the played voice (and so possibly you will have to move the labels). Press [MENU/ENTER] to confirm the load or [EXIT] to quit. |
| Overwriting pin-protected combinations are you sure? | You are loading a .ALL file and one or more Combinations Sets in the organ memory are protected by PIN. Press [MENU/ENTER] to confirm the load or [EXIT] to quit. |
| Song load failed Can't read file's properties | The system failed to load a MIDI file. The system cannot read the file's properties. The file or file system in the USB flash drive could be corrupted. Try to re-copy the file in |

| | |
|--|--|
| | the internal memory USB flash drive or to format it. If having problems with the internal memory, try again and then, if still having problems, contact the technical support at the e-mail address <i>service@viscount.it</i> communicating the error message. |
| Song load failed The MIDI file is too big | The system failed to load a MIDI file. The instrument cannot read .MID files bigger than 400 Kb. |
| Song load failed Can't open the MIDI file | The system failed to load a MIDI file. The system cannot read the file. Try to re-copy the file in the internal memory USB flash drive. |
| Song load failed Can't read the MIDI file | The system failed to load a MIDI file. The system cannot read the file. Try to re-copy the file in the internal memory USB flash drive. |
| Song load failed The MIDI file is corrupted | The system failed to load a MIDI file. The file is corrupted. The file or file system in the USB flash drive could be corrupted. Try to re-copy the file in the internal memory USB flash drive or to format it. |
| Songlist load failed Can't open file | The system failed to load the .LST file. It could not open the file. The file or file system in the USB flash drive could be corrupted. Try to re-copy the file in the internal memory USB flash drive or to format it. |
| Songlist load failed Can't read songs' number | The system failed to load the .LST file. It could not read the number of .MID files in the list. The file or file system in the USB flash drive could be corrupted. Try to re-copy the file in the internal memory USB flash drive or to format it. |
| Songlist load failed Can't read song's filename | The system failed to load a .LST file. The number of .MID files indicated in the song list is different from the actual number of .MID files present. |
| Songlist load failed Empty songlist | The system failed to load the .LST file. The list is empty. It is likely that the file was not created through the proper function in the SEQUENCER menu. |
| File save failed Can't create file | The system failed to save a .CMB or .ALL file, because it could not create a new file. |
| File save failed Can't write file's header | The system failed to save a .CMB or .ALL file, it could not write the file's header. |
| File save failed Can't write file's data | The system failed to save the .CMB or .ALL file because it couldn't write the file's data. |

Temperament

Tuning a fixed intonation instrument (e.g. organs) consists of creating a chain of twelve fifths, properly crafted so that at the extremes the interval can be reduced, through division or multiplication, to a perfect octave. A perfect fifth is achieved when two sounds have a frequency ratio of 3:2. If from any sound we calculate twelve ascending perfect fifths, the sound obtained is $(3/2)^{12}$. With 7 octaves instead, the result is a 2^7 frequency. If we compare these values we find that $(3/2)^{12}$ is slightly higher than 2^7 . Rounding off after the fourth decimal, we find that: $(3/2)^{12} = 129,7463$, while $2^7 = 128,0000$. The ratio between these two value is called **Pythagorean comma**. It can be defined as the surplus of twelve perfect fifth compared to seven octaves, both starting from the same sound.

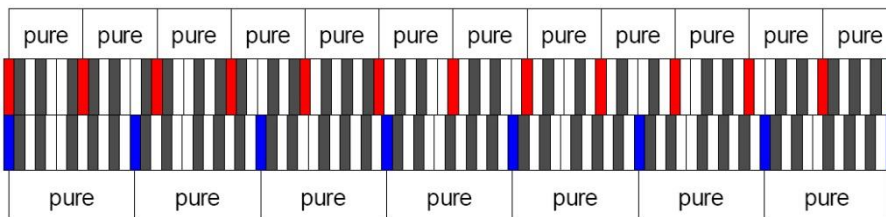

The picture is not in scale (otherwise the comma would be almost invisible) but it gives a graphical understanding of the problem.

Now, dividing the Pythagorean comma in 12 equal parts, and subtracting this value to each pure fifth, the result is a twelve-fifth chain, ending with the same value as seven octaves.

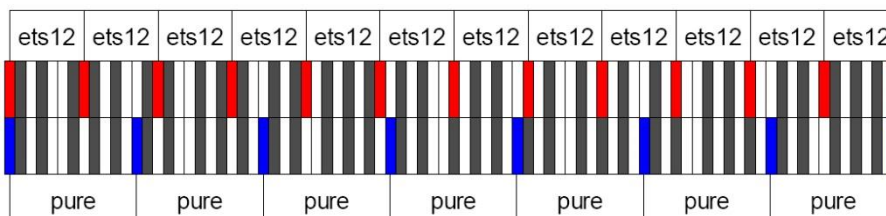

This is the Equal Temperament System (with the comma split in twelve parts).

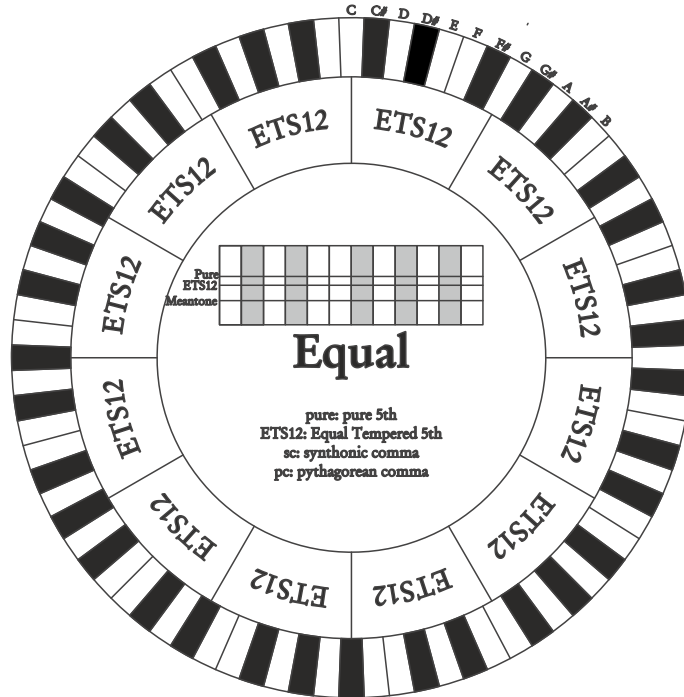

The Pythagorean comma can be split in larger parts and divided among a few (less than 12) fifths. This leads to other temperaments, such as the Werckmeister III, which spreads the comma in four, equal parts, between C-G, G-D, D-A, and B-F#.

A very important interval in the history of tuning is the major third. A chain of four pure fifths makes $(3/2)^4$. A major third interval is represented by a 5/4 ratio. Therefore, rounding off, the frequency of a major third, generated by Pythagorean fifths is 1,2656, while a natural major third is 1,2500. This surplus is called **Syntonic comma**.

A series of four fifths, each one reduced by 1/4 of Syntonic comma, makes a perfect major third. These fifths are called "meantone". If a temperament recovers only one syntonic comma, it still needs to compensate the small difference between Pythagorean and syntonic comma. This difference is called **skisma**.

For example, the Kirnberger II temperament is based on the syntonic comma. It spreads the comma equally between D-A and A-E and the skisma between F# and C#.

A series of three natural major thirds makes a frequency of $5/4^3$. The difference between that and the octave is called **enharmonic comma**.

When a temperament makes up for more than the Pythagorean comma, usually one fifth is much wider than the rest and becomes unusable. It is called the **wolf fifth**.

The circle of fifths of each temperament can start from any key editing the parameter called **Base Key**.

Follows an explicating graph: in the first half is represented Meantone temperament with Base Key set on C, after on G and finally on B. The second half shows Werkmeister temperament with the same three values of the Meantone. With the parameter Base Key set to C each temperament is built exactly as shown in the following circular graphs.

Base key: C

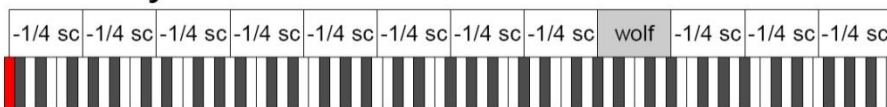

Base key: G

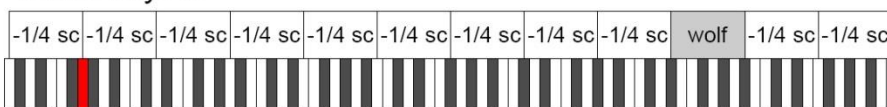

Base key: B

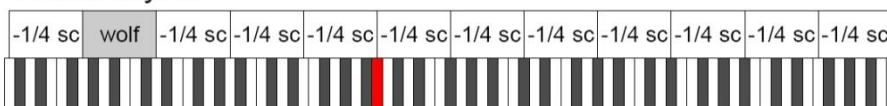

Base key: C

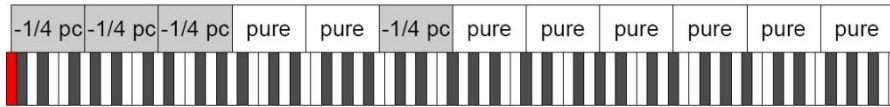

Base key: G

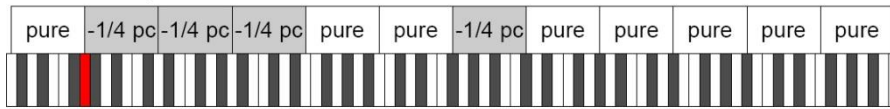

Base key: B

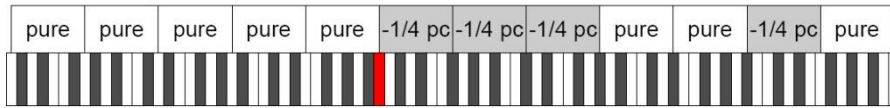

- 1/4 sc: a pure fifth narrowed by 1/4 of syntonic comma
- 1/4 pc: a pure fifth narrowed by 1/4 of pythagorean comma

Temperaments of the Physis Plus organs

In addition to Equal temperament, with the Physis Plus organs you can play other temperaments described below.

Kirnberger II

Based on two fifths, reduced by half syntonic comma, and one fifth reduced by a skisma. There are three pure majors: C, G, D. Therefore, the major triads on C and G are pure. Same goes with the minor triads, on E and B. The four major thirds on C#, G#, Eb, Bb are Pythagorean. The coexistence of pure and tempered chords gives a peculiar character to this tuning.

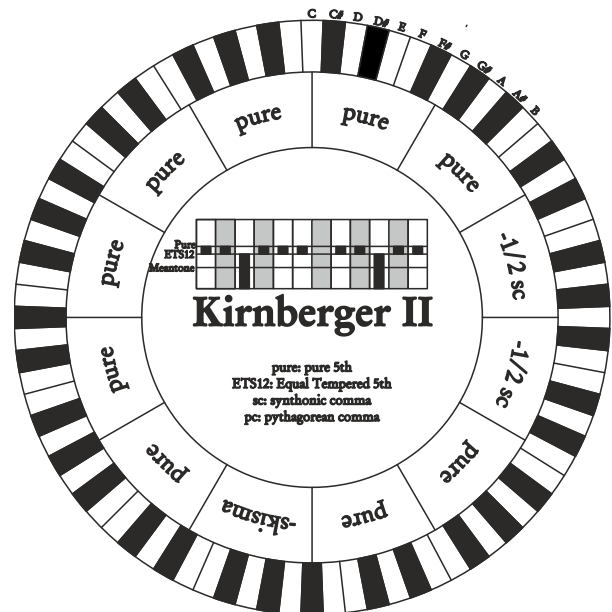

Werckmeister III

Based on four fifths, each reduced by 1/4 Pythagorean comma – the others are pure. Creates three Pythagorean major thirds on: C#, F#, G#. As the number of alteration in the piece performed increases, so does the harmonic tension.

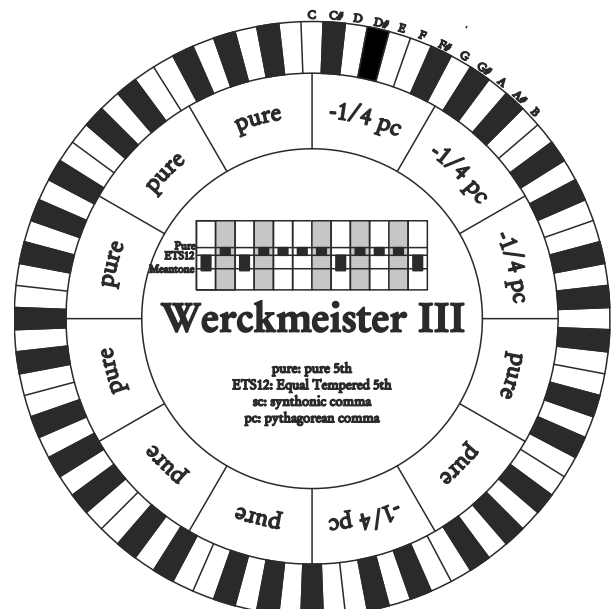

Pythagorean

Based on eleven pure Pythagorean fifths and a wolf fifth on G#. This tuning can be used to play monodies, and music that does not use thirds in general. Most useful for curiosity and educational ends.

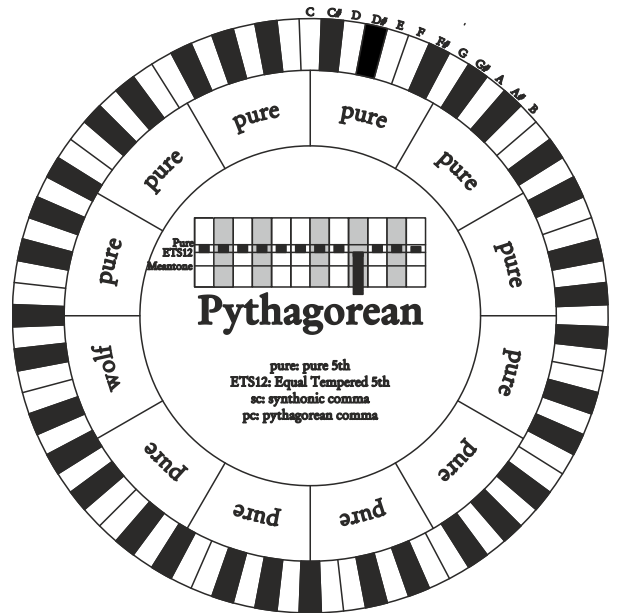

Meantone 3# - Meantone 3b

This tuning is the prototype of all temperaments based on fifths reduced by 1/4 of syntonic comma. This generates eight pure major thirds: Eb, Bb, F, C, G, D, A, E. However, the other thirds are unusable (B, F#, G#). The fifths are defined as meantone fifths: shorter than pure fifths but still sounding well. Only one, G#, fills all the gap created by 11 others and becomes a wolf fifth. Tonalties with little alterations sound very pleasant. Well characterised chromatic scale. Move the wolf on C# to use the G# key as Ab.

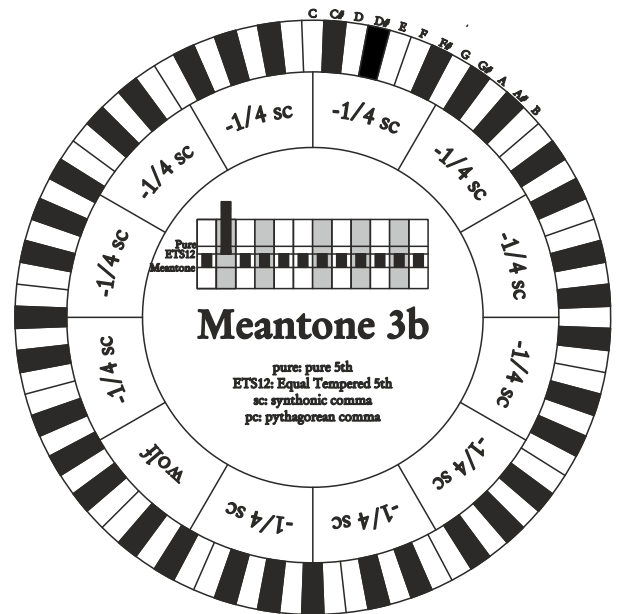
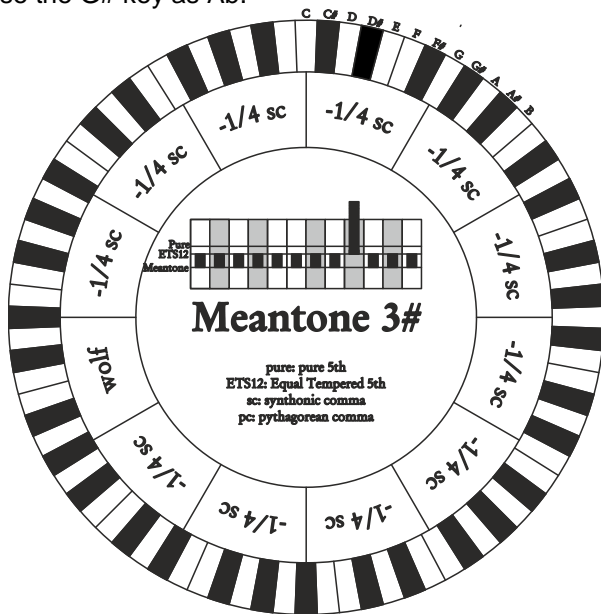

Vallotti

Based on six fifths, each decreased by 1/6 of Pythagorean comma. The others are pure fifths. The major thirds on Eb-B, Bb-E, F-A are equivalent, as the ones on C, G and D. Thirds on F#, C# and G# are Pythagorean instead.

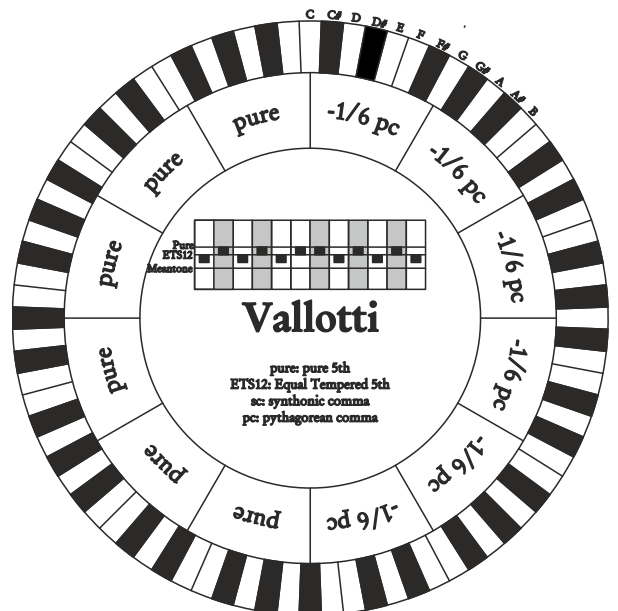

Chaumont

A meantone temperament; the wolf fifth has been improved by enlarging the fifths on Eb and Bb. There are six pure major thirds: F, C, G, D, A, E. The third major on B, although not very pleasant, can still be used.

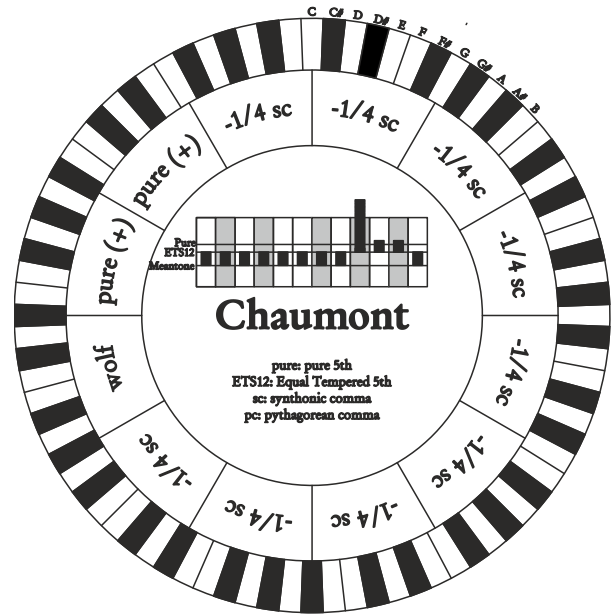

Kellner 1975

This tuning was created by Kellner, who figured out its structure from the symbols on the first page of the "Wohltemperierte Klavier" by Bach, 1722. The tuning is based on five fifths, each reduced of 1/5 of Pythagorean comma. This originates three Pythagorean major thirds, on: C#, F#, G#. None of the thirds is pure. The major third closer to being pure is on C.

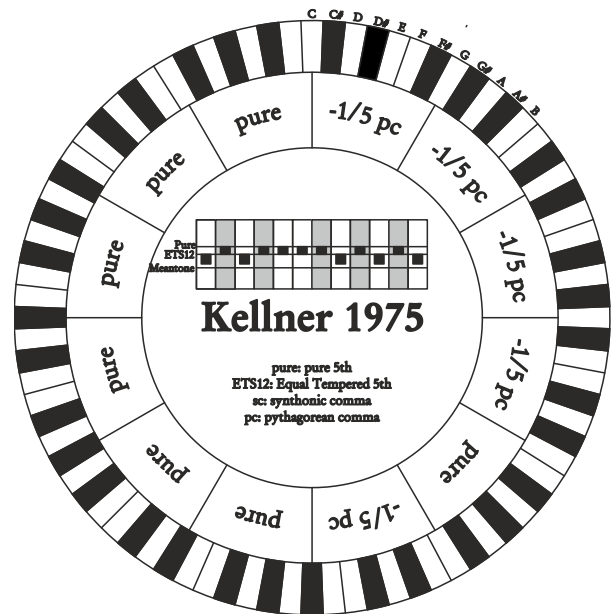

Kirnberger III

Based on four fifths, each one reduced by 1/4 of syntonic comma, and one fifth reduced of the remaining skisma. There is only one pure major third on C. From most to least pure, they are G, D, A and F, Bb, Eb. E, B and F# are equivalent one with the other. Pythagorean major thirds are on C# and G#. Pieces with many alterations are well characterised.

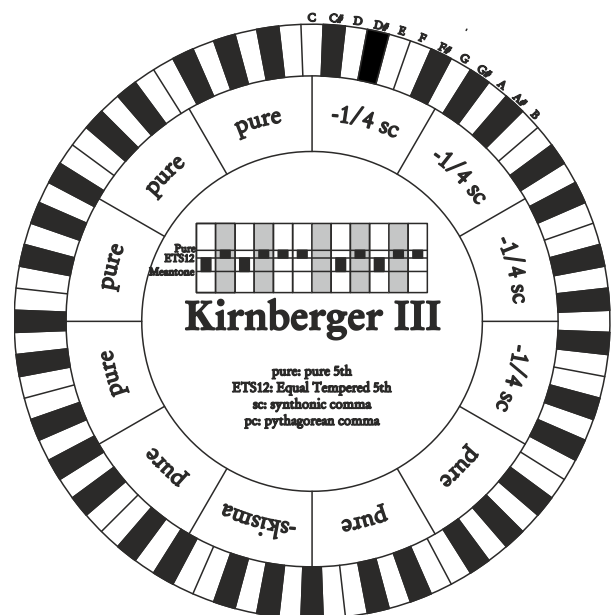

Werckmeister IV

Based on five fifths, each reduced of 1/3 of Pythagorean comma, and two more thirds increased of the same amount. Very pleasant with mostly unaltered tonalities, it becomes "harder" as the alterations increase.

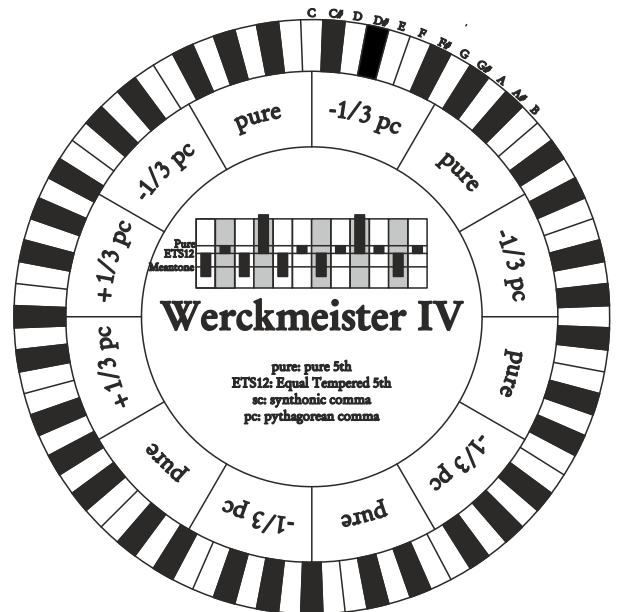

Werckmeister V

Based on five fifths reduced by 1/5 of Pythagorean comma, and one fifth increased of the same amount. This tuning is rarely used as there is no tonality that is much euphonic.

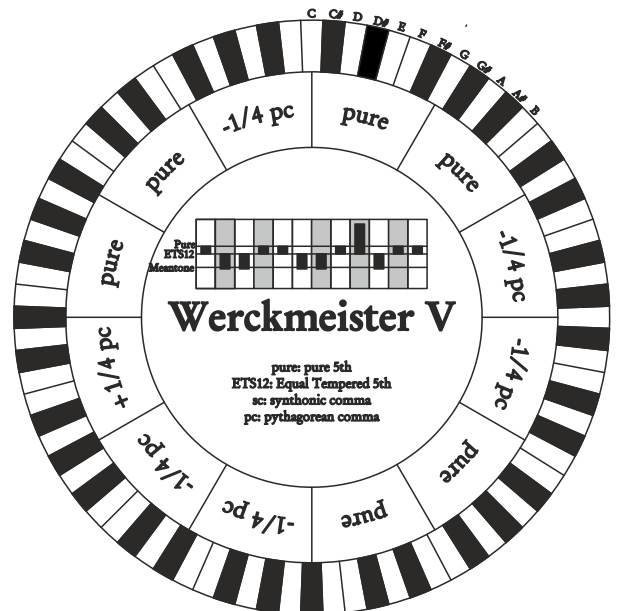

Silbermann

Based on fifths reduced of 1/6 of syntonic comma. Wolf fifth is located on G#. Thirds that in meantone tuning are pure, here are 1/3 syntonic comma wider. The wolf fifth is less prominent, not cacophonous yet not completely acceptable.

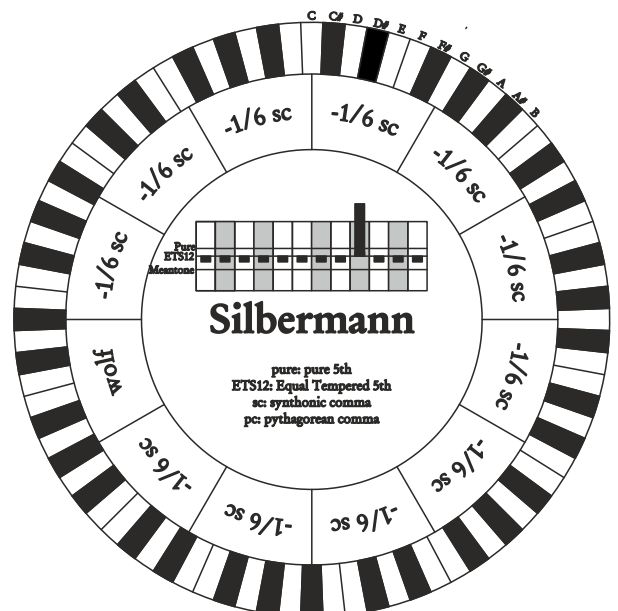

Meantone Pure Minor 3rd

This temperament is built with fifths narrowed by 1/3 of syntonic comma. The wolf fifth on G# is very large and completely unusable. The nine minor thirds based on C, G, D, A, E, B, F#, C#, G# are pure. The eight major thirds based on Eb, Bb, F, C, G, D, A, E, are narrower, with respect to the pure, by 1/3 of syntonic comma. Again in this temperament the chromatic scale has a particular character.

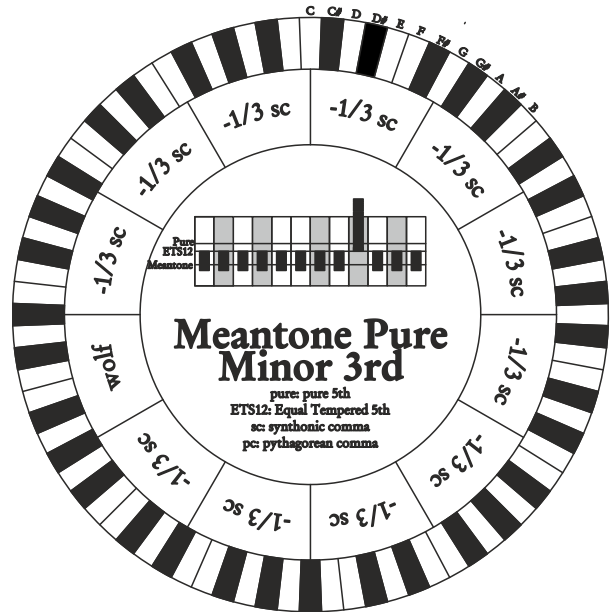

Zarlino

Eleven fifths are reduced by 2/7 of syntonic comma. The wolf fifth, very wide and therefore unusable, lies on G#. Eight third majors are usable and reduced by 1/7 of syntonic comma. Well characterised chromatic scale.

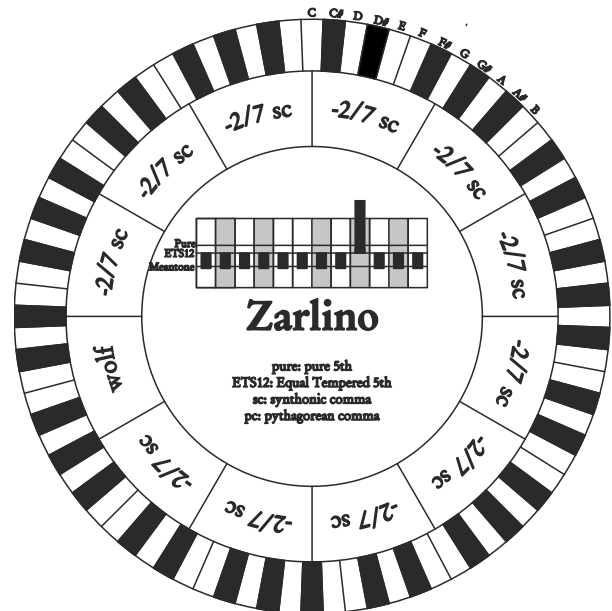

Sauveur 1 – Sauveur 2

The Saveur 1 tuning is based on eleven fifths, reduced by 1/5 of syntonic comma. Wolf fifth lies on G#. In Saveur 2 the fifth on F# is pure. The eight third majors of the meantone are somewhat wider here, so the “wolf” is less prominent. Well tuned tonalities are particularly “warm” and pleasant.

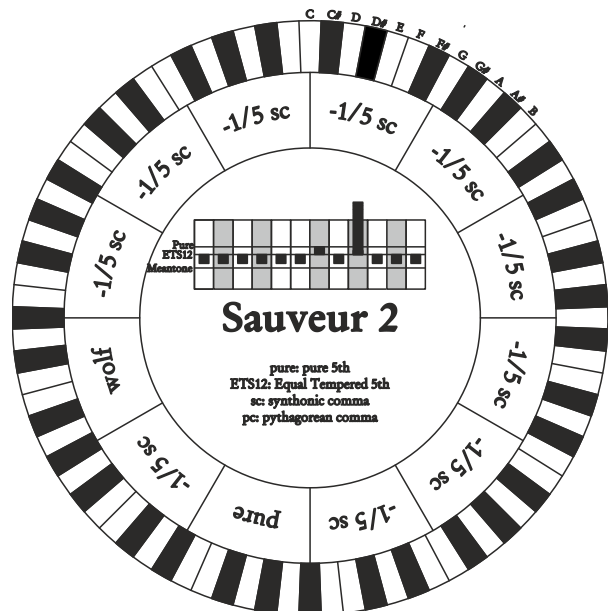
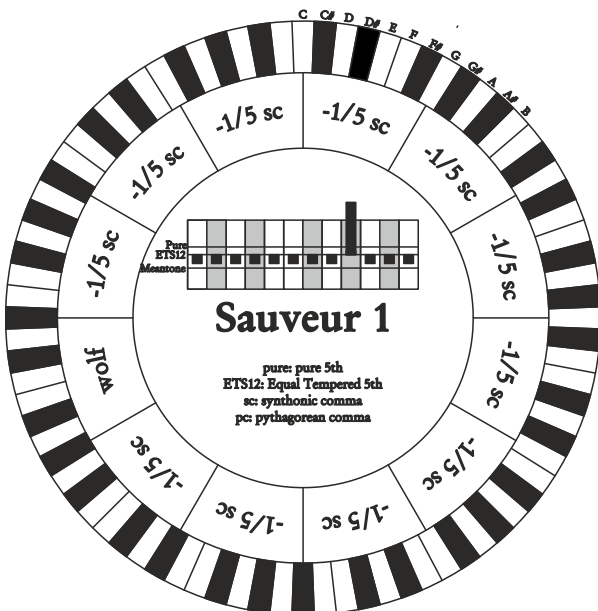

Barca

The Barca temperament is based on six fifths (from C) reduced by 1/6 of syntonic comma each, and one fifth (on Eb) reduced of the remaining skisma. Therefore there are no Pythagorean thirds, and tonalities with many alterations still sound well.

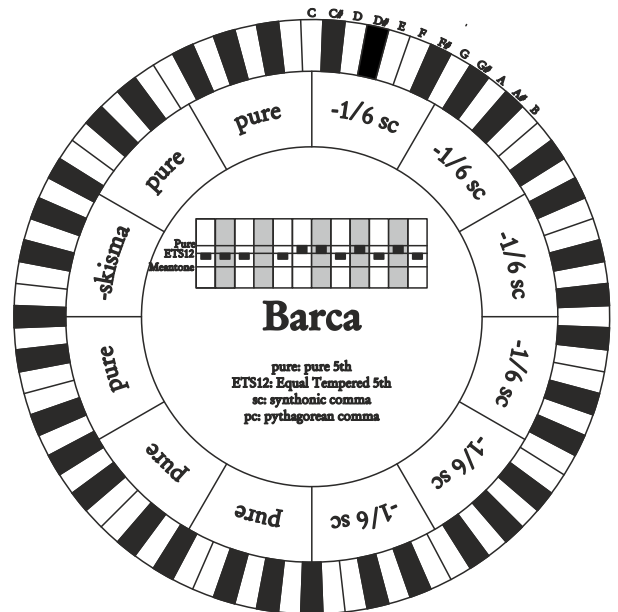

Neidhardt II

It consists of three pure fifths on E, Ab and F; three reduced by 1/6 of a Pythagorean comma on C, G and D; the remaining six on A, B, F#, C#, Eb and Bb, reduced by 1/12 of a Pythagorean comma. It shares the exact intonation of six keys with Vallotti's Temperament: C, G, D, A, Eb and Ab. The other six are shifted slightly in favor of better euphony in the case of many accidentals. It is therefore a circulating temperament that allows you to play in all keys.

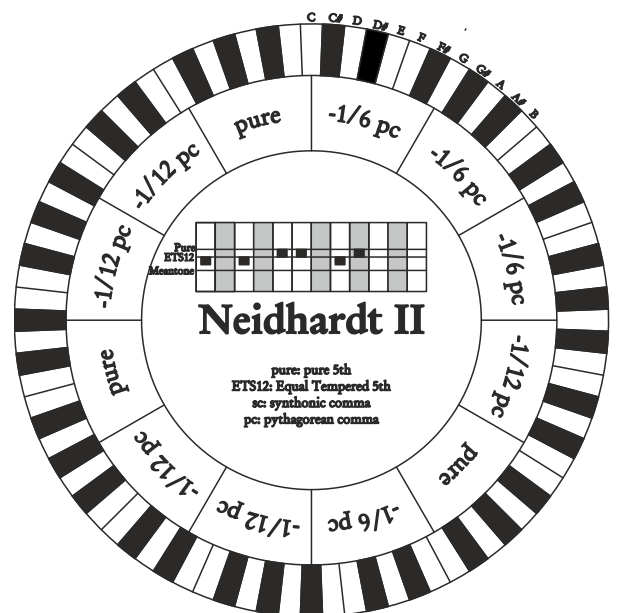

The windchest in pipe organs

The windchest is a crate where the air from a bellows (manual or electric) is spread equally among the pipes. Usually, each manual has its own wind chest. However, there are different kinds of wind chests: some contain only one stop, while other have an additional crate filled with air from the bellows that spreads air to all the stops for each note.

Here you will find a short description of each kind of wind chest simulated by the organ.

Single cusp

The tallest, broadest pipes are located in the centre. As the pitch rises the pipes are gradually distributed further and further to the outside, alternating (e.g. C to the right, C# left).

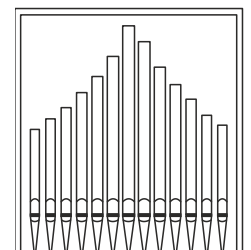

Double cusp

there are two separate cusps, both resembling to the single cusp described above. The lowest keys sound in an intermediate position, between the centre and the outside, alternating (one on the right cusp, one on the left cusp). As the pitch rises, rises the pipes are gradually distributed further and further to the outside, alternating (e.g. C right, C# left).

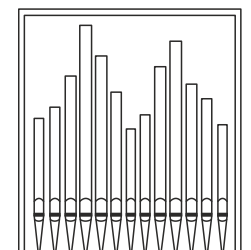

Double wing

The tallest pipes are placed in the centre. As the pitch lowers, the pipes are gradually distributed further and further to the outside, alternating.

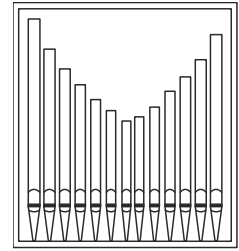

Single wing (left)

The tallest pipes are placed to the left, and the smaller (with higher pitch) pipes to the right.

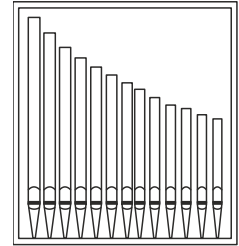

Single wing (right)

This pipe configuration is the opposite of the previous one: the lowest pitched pipes are placed on the right and the highest pitched ones to the left.

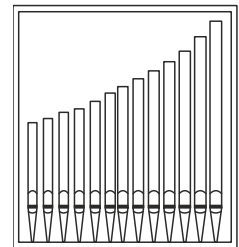

Center

All the pipes are placed in the central position inside the wind chest, so the sound is not affected by the position of the pipes.

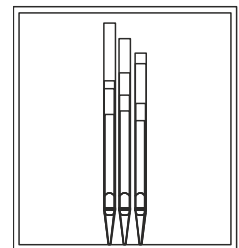

Alternated

The pipes are placed alternating in two positions (e.g. C in one position, C# in the other).

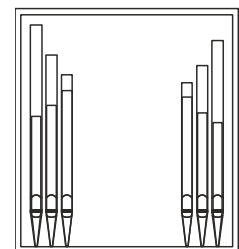

What MIDI is

The MIDI interface (Musical Instrument Digital Interface) allows instruments of different makes and kinds to communicate with each other, using this very specific protocol of codes. This allows the creation of systems of MIDI instruments, offering much greater versatility and control than is possible with single instruments. To make this communication possible, all MIDI instruments have two or three 5-pin DIN connectors called:

- **MIDI IN:** The connector through which the instrument receives the MIDI data transmitted by other units.
- **MIDI OUT:** The connector through which the instrument sends the MIDI data it has generated to other units.
- **MIDI THRU:** This connector, not always provided on all instruments, is used for connecting several units in series, since it transmits the MIDI data exactly as they are received by the respective MIDI IN port.

Most instruments equipped with MIDI interface transmit MIDI messages which specify, for example, which note has been played and with what dynamic, by means of the MIDI OUT connector. If this connector is connected to the MIDI IN connector of another MIDI instrument, such as an expander, the second instrument will respond exactly to the notes played on the transmitter instrument.

The same type of information transfer is used for recording MIDI sequences. A computer or a sequencer can be used to record the MIDI data generated by the transmitter instrument. If these recorded data are sent back to the instrument, it automatically repeats the recorded performance.

MIDI is able to transmit a multitude of digital data by means of just one cable, and thus just one connector. This is thanks to the MIDI channels. There are 16 MIDI channels, and in a similar way as for radio communications in which two stations can only communicate if they are tuned to the same frequency (or channel), two MIDI instruments connected together are only able to communicate if the transmitter instrument channel is the same as the receiver instrument channel.

MIDI messages subdivide into channel messages and system messages. The following is a short description of these messages:

CHANNEL MESSAGES

Note On

This message is transmitted when a note is depressed on the keyboard. Each Note On message contains the following information:

Note On: when a key has been struck;

Note Number: the key which has been pressed, and therefore the relative note played;

Velocity: note velocity (i.e. the force applied when the key was struck).

Note messages are expressed as a number from 0 to 127, with middle C represented by number 60.

Note Off

This message is transmitted when a key struck previously is released.

When it is received, the sound of the note relating to the key is switched off. Each Note On message contains the following information:

Note Off: a key has been released;

Note Number: which key has been released;

Velocity: velocity (i.e. how fast the note was released).

NOTE

A Note On message with Velocity=0 is considered equivalent to a Note Off message.

Program Change

This message is used to select the programs or sounds of the receiver instrument.

There is also a specific standard called General MIDI which describes which sound should be recalled for each Program Change received. This association is usually described by means of a table included in the user manual of the instrument which adopts the standard.

This message contains the following information:

Program Change: voice or program change;

Program Change Number: the number of the program or voice to be activated;

Control Change

These are control messages (often associated to trimmers or pedals) used to add expression to the performance, allowing you to set (and control in real time if necessary) voice parameters such as volume (CC n.7) or the position of the swell pedals (CC n.11), etc.

This message contains the following information:

Control Change: a controller has been adjusted

Controller Number: which controller has been adjusted

Controller Position: the position of the controller

SYSTEM MESSAGES

System Exclusive

These messages can only be interpreted by an instrument made by the same producer as the transmitter device (in some cases only by the same model). They mainly relate to the instrument's sound generation and programming parameters. The organ uses these messages to control all the internal parameters and for switching the voices on and off.

Real Time

The Real Time messages also include the Active Sensing code, sent to keep the dialogue between two MIDI instruments alive. When the receiver instrument does not receive any MIDI data or the Active Sensing code in a time interval of about 300 milliseconds, it considers the MIDI connection to have been deactivated, so it switches off any notes still active. Remember that the transmission and reception of this message is optional, so not all instruments are equipped to handle it.

Detailed MIDI Implementation

CHANNEL MESSAGES

Using default settings, channel messages are sent and received on the following MIDI channels:

4 manuals models:

- Ch.1: Manual IV / Solo notes and controls
- Ch.1: Manual III / Swell notes or controls
- Ch.2: Manual II / Great notes or controls
- Ch.3: Manual I / Choir notes or controls
- Ch.4: Pedal notes or controls

3 manuals models:

- Ch.1: Manual III / Swell notes or controls
- Ch.2: Manual II / Great notes or controls
- Ch.3: Manual I / Choir notes or controls
- Ch.4: Pedal notes or controls

2 manuals models:

- Ch.1: Manual II / Great notes or controls
- Ch.2: Manual I / Choir notes or controls
- Ch.4: Pedal notes or controls

Ch.16 is a reserved channel (system)

Note On

Message which is generated when a key is pressed.

Data format: 9nH kkH vvH

n=channel number :0H-EH (1-15)
 kk=note number :1EH-65H (30-101)
 vv=note on velocity :01H-7FH (1-127)
 :00H (0) Note Off

Note Off

Message which is generated when a key is released.

Data format: 8nH kkH vvH
 9nH kkH 00H

n=channel number :0H-EH (1-15)
 kk=note number :1EH-65H (30-101)
 vv=note off velocity :00H-7FH (0-127)
 ignored

- This message can be also received as Note On with velocity=0.

Control Change

Messages to control volumes, expressions and other system controls.

• Bank Select MSB (CC 0)

Controller transmitted in combination of Program Change and Bank Select LSB in order to select a specific bank of sound. It can be transmitted using the PRG IN COMBIN. function and when stored in the combinations and Tutti.

It also can be received on channel 16 to select the Memory Bank.

Data format: BnH 00H vvH

n=channel number :0H-EH (1-15)
 vv=bank MSB number :00H-7FH (0-127)

• Volume (CC 7)

Message which controls the sections volume.

Data format: BnH 07H vvH

n=channel number :0H-EH (1-15)
 vv=volume value :00H-7FH (0-127)

• Expression (CC 11)

Message which controls the sections expression.

Data format: BnH 0BH vvH

n=channel number :0H-EH (1-15)
 vv=expression value :00H-7FH (0-127)

• Bank Select LSB (CC 32)

Controller transmitted in combination of Program Change and Bank Select MSB in order to select a specific bank of sound. It can be transmitted using the PRG IN COMBIN. function and when stored in the combinations and Tutti.

Data format: BnH 20H vvH

n=channel number :0H-EH (1-15)
 vv=bank LSB number :00H-7FH (0-127)

• Sustain (CC 64)

Message which controls the Sustain effect.

Data format: BnH 40H vvH

n=channel number :0H-EH (1-15)
 vv=switch :00H (0) off
 (received as 00H-39H)
 :7FH (127) on
 (received as 40H-7FH)

• All Sounds Off (CC 120)

Terminates all voices currently on for the specific channel.

Data format: BnH 78H 00H

n=channel number :0H-EH (1-15)

• Reset All Controllers (CC 121)

Controllers are set to the default value.

Data format: BnH 79H 00H

n=channel number :0H-EH (1-15)

- This message is transmitted only.

• **All Notes Off (CC 123)**

Terminates all notes currently on for the specific channel.

Data format: BnH 7BH 00H

n=channel number :0H-EH (1-15)

Program Change

Messages for selecting sounds, timbres or programs in external modules. It also can be received by the organ to recall combinations, Tutti and Crescendo steps.

Control Change 0 can be used to select Memory Banks.

Data format: CnH mmH

Transmitted:

n=channel number :0H-EH (1-15)
mm=Program Ch. number:00H-7FH (0-127)

Received:

n=channel number :FH (16)
mm=Program Ch. number:
00H (0): general HR
01H-0CH (1-12): general combinations 1-12
10H (16): Pedal HR
11H-16H (17-22): Pedal combinations 1-6
20H (32) (3,4-manual models): Man.II HR
20H (32) (2-manual models): Man.I HR
21H-26H (33-38) (3,4-manual models):
Man.II combin. 1-6
21H-26H (33-38) (2-manual models):
Man.I combin. 1-6
30H (48) (3,4-manual models): Man.III HR
30H (48) (2-manual models): Man.II HR
31H-36H (49-54) (3,4-manual models):
Man.III combin. 1-6
31H-36H (49-54) (2-manual models):
Man.II combin. 1-6
40H (64) (3,4-manual models): Man.I HR
41H-46H (65-70) (3,4-manual models):
Man.I combin. 1-6
50H (80): Man.IV HR
51H-56H (81-86): Man.IV combin. 1-6
60H (96): Tutti OFF
61H (97): Tutti ON
62H(98) (3,4-manual models): Man.II Plenum OFF
63H(99) (3,4-manual models): Man.II Plenum ON
62H(98) (2-manual models): Man.I Plenum OFF
63H(99) (2-manual models): Man.I Plenum ON
64H(100) (3,4-manual models):Man.III Plenum OFF
65H(101) (3,4-manual models):Man.III Plenum ON
64H(100) (2-manual models): Man.II Plenum OFF
65H(101) (2-manual models): Man.II Plenum ON
66H(102) (3,4-manual models): Man.I Plenum OFF
67H(103) (3,4-manual models): Man.I Plenum ON
68H (104): Man.IV Plenum OFF
69H (105): Man.IV Plenum ON
6AH (106): Plenum OFF
6BH (107): Plenum ON
6CH (108): Reed OFF
6DH (109): Reed ON
6FH (111): Crescendo - (OFF)
70H-7FH (112-127): Crescendo steps 1-16

STANDARD SYSTEM EXCLUSIVE MESSAGES

• **Device Inquiry**

Instrument information sent after switching on and when a Device Inquiry Request is received.

Data format: F0H 7EH 00H 06H 02H 31H ffH
ffH mmH mmH xxH yyH zzH vvH F7H

F0H: Exclusive status
7EH: Universal Non Realtime message
00H: channel
06H: general information
02H: device ID reply
31H: Viscount ID
ffH ffH: device family code
mmH mmH: device family member code
xxH yyH zzH vvH: software version
F7H: End of Exclusive

• **Master Fine Tuning**

Parameter: Tuning
Video page: Tuning

Data format: F0H 7FH 7FH 04H 03H vvH nnH
F7H

F0H: Exclusive status
7FH: Universal Realtime message
7FH: channel (any)
04H: Sub-ID #1=Device Control message
03H: Sub-ID #2=Master Fine tuning
vvH nnH: fine tuning value
00H 00H: A4=415,30 Hz
00H 40H: A4=440 Hz
7FH 7FH: A4=466,16 Hz
F7H: End of Exclusive

- This message is transmitted only.

• **Temperament**

Parameter: Temperament
Video page: Tuning

Data format: F0H 7EH 7FH 08H 08H 03H 7FH
7FH [ss] ... F7H

F0H: Exclusive status
7EH: Universal Non Realtime message
7FH: channel (any)
08H: Sub-ID #1=MIDI Tuning standard
08H: Sub-ID #2=scale/octave tuning 1-byte
form (Non Real-Time)
03H: channel/options byte 1
7FH: channel byte 2
7FH: channel byte 3
[ss]:12 byte tuning offset of 12 semitones
from C to B
00H: -64 cents
40H: 0 cents
7FH: +64 cents
F7H: End of Exclusive

- This message is transmitted only.

VISCOUNT SYSTEM EXCLUSIVE MESSAGES

• Register on/off

Data format: F0H 31H snH xxH yyH F7H

F0H: Exclusive status
 31H: Viscount ID
 sH : switch
 0H=voice off
 4H=voice on
 nH : channel number (0H-EH, 1-15)
 xxH: voice id - first byte
 yyH: voice id - second byte
 F7H: End of Exclusive

• Tremulant or Tremolo on/off

Data format: F0H 31H 2nH 5EH 00H ttH ssH F7H

F0H: Exclusive status
 31H: Viscount ID
 2nH: channel number (n=0H-EH, 1-15)
 5EH: tremulant parameter
 00H: tremulant switch
 ttH: tremulant number
 00H=1st tremulant
 01H=2nd tremulant
 ssH: switch
 00H=tremulant off
 01H=tremulant on
 F7H: End of Exclusive

• Tremulant or Tremolo parameters

Parameter: Depth, Speed, Amplitude, Shape
 Video page: Tuning / Tremulants or Tremolos

Data format:

F0H 31H 2nH 5EH 01H ttH ppH vvH F7H

F0H: Exclusive status
 31H: Viscount ID
 2nH: channel number (n=0H-EH, 1-15)
 5EH: tremulant parameter
 01H: tremulant values
 ttH: tremulant number
 00H=1st tremulant
 01H=2nd tremulant
 ppH: parameter
 00H=depth
 01H=speed
 02H=amplitude
 03H=shape
 vvH: value (04H-20H for speed and depth,
 00H-07H for amplitude, 00H-01H for
 shape)
 F7H: End of Exclusive

- Messages of Depth, Speed, Amplitude and Shape parameters are always transmitted when the Tremulant/Tremolo is switched on and off.

• Air Pressure

Parameter: Air Pressure
 Video page: Tuning

Data format: F0H 31H 2FH 2EH vvH F7H

F0H: Exclusive status
 31H: Viscount ID
 2FH: system control
 2EH: air pressure
 vvH: air pressure value (40H-48H, 64-72)
 F7H: End of Exclusive

• Ensemble

Parameter: Ensemble
 Video page: Tuning

Data format: F0H 31H 2FH 32H vvH F7H

F0H: Exclusive status
 31H: Viscount ID
 2FH: system control
 32H: ensemble
 vvH: ensemble value (40H-48H, 64-72)
 F7H: End of Exclusive

• Pitch

Parameter: Pitch
 Video page: Tuning

Data format: F0H 31H 2FH 67H 00H 0nH 0nH
 0nH F7H

F0H: Exclusive status
 31H: Viscount ID
 2FH: system control
 67H: pitch
 0nH 0nH 0nH: nibblezed data of pitch value
 00H 01H 08H: A=415,30 Hz
 04H 00H 00H: A=440 Hz
 07H 0EH 08H: A=466,16 Hz
 F7H: End of Exclusive

• Cancel

Data format: F0H 31H 2FH 6CH 00H F7H

F0H: Exclusive status
 31H: Viscount ID
 2FH: system control
 6CH: cancel
 00H: execute cancel
 F7H: End of Exclusive

• Couplers (3 and 4 manuals organ models)

Data format: F0H 31H 2FH 70H vvH F7H

F0H: Exclusive status
 31H: Viscount ID
 2FH: system control
 70H: coupler
 vvH: type and switch
 00H=III/P or SW/P on
 10H=III/P or SW/P off
 01H=II/P or GT/P on
 11H=II/P or GT/P off
 02H=I/P or CH/P on
 12H=I/P or CH/P off
 03H=III/II or SW/GT on
 13H=III/II or SW/GT off
 04H=I/II or CH/GT on
 14H=I/II or CH/GT off
 05H=III/I or SW/CH on
 15H=III/I or SW/CH off
 F7H: EOX

- This message is received only.

Data format: F0H 31H 2FH 70H 7FH vvH nnH F7H

F0H: Exclusive status
 31H: Viscount ID
 2FH: system control

70H: coupler
 7FH: other coupler
 vvH nnH:type and switch
 04H 21H:IV/P or SO/P on
 04H 20H:IV/P or SO/P off
 14H 21H:IV/II or SO/GT on
 14H 20H:IV/II or SO/GT off
 24H 21H:IV/III or SO/SW on
 24H 20H:IV/III or SO/SW off
 34H 21H:IV/I or SO/CH on
 34H 20H:IV/I or SO/CH off
 F7H: End of Exclusive

- This message is received only.

• **Couplers (2 manuals organ models)**

Data format: F0H 31H 2FH 70H vvH F7H

F0H: Exclusive status
 31H: Viscount ID
 2FH: system control
 70H: coupler
 vvH: type and switch
 00H=II/P or SW/P on
 10H=II/P or SW/P off
 01H=I/P or GT/P on
 11H=I/P or GT/P off
 03H=II/I or SW/GT on
 13H=II/I or SW/GT off
 F7H: End of Exclusive

- This message is received only.

• **Sub- and super-octave**

Data format: F0H 31H 2FH 70H 7FH vvH ssH F7H

F0H: Exclusive status
 31H: Viscount ID
 2FH: system control
 70H: coupler
 7FH: other coupler
 vvH ssH:type and switch
 02H 31H=Super Octave III/P or SW/P on
 02H 30H=Super Octave III/P or SW/P off
 03H 31H=Super Octave I/P or CH/P on
 03H 30H=Super Octave I/P or CH/P off
 04H 31H=Super Octave IV/P or SO/P on
 04H 30H=Super Octave IV/P or SO/P off
 22H 11H=Sub Octave III or SW on
 22H 10H=Sub Octave III or SW off
 22H 21H=Unison Off III or SW on
 22H 20H=Unison Off III or SW off
 22H 31H=Super Octave III or SW on
 22H 30H=Super Octave III or SW off
 12H 11H=Sub Octave III/II or SW/GT on
 12H 10H=Sub Octave III/II or SW/GT off
 12H 31H=Super Octave III/II or SW/GT on
 12H 30H=Super Octave III/II or SW/GT off
 13H 11H=Sub Octave I/II or CH/GT on
 13H 10H=Sub Octave I/II or CH/GT off
 13H 31H=Super Octave I/II or CH/GT on
 13H 30H=Super Octave I/II or CH/GT off
 14H 11H=Sub Octave IV/II or SO/GT on
 14H 10H=Sub Octave IV/II or SO/GT off
 14H 31H=Super Octave IV/II or SO/GT on
 14H 30H=Super Octave IV/II or SO/GT off
 32H 11H=Sub Octave III/I or SW/CH on
 32H 10H=Sub Octave III/I or SW/CH off
 32H 31H=Super Octave III/I or SW/CH on
 32H 30H=Super Octave III/I or SW/CH off
 33H 11H=Sub Octave I or CH on
 33H 10H=Sub Octave I or CH off

34H 11H=Sub Octave IV/I or SO/CH on
 34H 10H=Sub Octave IV/I or SO/CH off
 34H 31H=Super Octave IV/I or SO/CH on
 34H 30H=Super Octave IV/I or SO/CH o
 F7H: End of Exclusive

• **Orchestra volume**

Parameter: ORC

Video page: Levels

Data format: F0H 31H 2FH 72H vvH F7H

F0H: Exclusive status
 31H: Viscount ID
 2FH: system control
 72H: orchestra volume
 vvH: orchestra volume value (00H-7FH, 0-127)
 F7H: End of Exclusive

• **Orchestral Voice Change**

Data format: F0H 31H 2nH 41H xxH yyH iiH ttH v1H v2H b1H b2H o1H o2H u1H u2H kkH F7H

F0H: Exclusive status
 31H: Viscount ID
 2nH: channel number (n=0H-EH, 0-15)
 41H: orchestral voice change
 xxH: voice id - first byte
 yyH: voice id - second byte
 iiH: alternative voice id
 ttH: timbre type
 05H=single
 06H=layer
 07H=split
 v1H:voice1/L volume
 v2H:voice2/R volume
 b1h: voice1/L brilliance
 b2h: voice2/R brilliance
 o1H:voice1/L octave shift
 o2H:voice2/R octave shift
 u1H:voice1/L sustain enable
 u2H:voice2/R sustain enable
 kkH: split key
 F7H: End of Exclusive

- This message is transmitted only when an alternative orchestral voices changes after recalling a combination.
- With Single type, voice2 bytes are fixed to 40H
- With Single and Layer types, "split key" byte is not used.
- After recalling a combination, if the orchestral voice is setted as in the Organ Style, the message change to: F0H 31H 2sH 41H xxH yyH 00H 7FH 00H 00H 00H 00H 00H 00H 00H 00H 00H 00H F7H

SYSTEM REAL TIME MESSAGES

FEH: Active Sensing

FEH is transmitted every 300 msec. whenever is no other MIDI data being transmitted.

MIDI IMPLEMENTATION CHART

Viscount Pheiss Plus Organs
Classic Organ

Version: 1.0
Date: 30 Aug. 2023

| FUNCTION... | TRANSMITTED | RECEIVED | REMARKS |
|--|--------------------------------------|--------------------------------------|--|
| BASIC CHANNEL Default Changed | 1,2,3,4,5 1÷15 | 1,2,3,4,5 1÷15 | *1 |
| MODE Default Messages Altered | Mode 3 ***** ***** | Mode 3 ***** ***** | |
| NOTE NUMBER True Voice | 30÷101 36÷96 | 30÷101 30÷101 | |
| VELOCITY Note ON Note OFF | O O | O O | |
| AFTER TOUCH Key's Ch's | X X | X X | |
| PITCH BENDER | X | X | |
| CONTROL CHANGE 0 7 11 32 64 120 121 123 | O O O O O O O O | O O O O O O O O | Bank Select MSB Volume Expression Bank Select LSB Sustain All Sound Off Reset All Controllers All Notes Off |
| PROGRAM CHANGE True# | O | O | *1 |
| SYSTEM EXCLUSIVE | O | O | *1 |
| SYSTEM COMMON Song Pos Song Sel Tune | X X X | X X X | |
| SYSTEM REAL TIME Clock Commands | X X | X X | |
| AUX MESSAGES Local On-Off All Notes Off Active Sense Reset | X O O X | X O O X | |
| NOTES: *1: see Detailed MIDI Implementation for further informations | | | |

Mode 1: Omni On, Poly
Mode 3: Omni Off, Poly

Mode 2: Omni On, Mono
Mode 4: Omni Off, Mono

O=YES
X=NO

Disposal of old Electrical & Electronic Equipment (Applicable throughout the European Union and other European countries with separate collection programs)



Dir. 2002/95/CE, 2002/96/CE e 2003/108/CE

This symbol, found on your product or on its packaging, indicates that this product should not be treated as household waste when you wish to dispose of it. Instead, it should be handed over to an applicable collection point for the recycling of electrical and electronic equipment. By ensuring this product is disposed of correctly, you will help prevent potential negative consequences to the environment

and human health, which could otherwise be caused by inappropriate disposal of this product. The recycling of materials will help to conserve natural resources. For more detailed information about the recycling of this product, please contact your local city office, waste disposal service or the retail store where you purchased this product.



This product complies with the requirements of EMCD 2004/108/EC and LVD 2006/95/EC.

FCC RULES

NOTE: This equipment has been tested and found to comply with the limits for a **Class B** digital Device, pursuant to Part 15 of the FCC Rules. These limits are designed to provide reasonable protection against harmful interference in a residential installation. This equipment generates, uses and can radiate radio frequency energy and, if not installed and used in accordance with the instruction, may cause harmful interference to radio communications. However, there is no guarantee that the interference will not occur in a particular installation. If this equipment does cause harmful interference to radio or television reception, which can be determined by turning the equipment off and on, the user is encouraged to try to correct the interference by one or more of the following measures:

- Reorient or relocate the receiving antenna.
- Increase the separation between the equipment and receiver.
- Connect the equipment into an outlet on a circuit different from that to which the receiver is connected.
- Consult the dealer or an experienced Radio/TV technician for help.

The user is cautioned that any changes or modification not expressly approved by the party responsible for compliance could void the user's authority to operate the equipment.

INFORMATIONS FCC

NOTE : Cet instrument a été contrôlé et il est garanti pour être en conformité avec les spécifications techniques établies pour les dispositifs numériques de la « **Classe B** » selon les normes de protection contre les interférences avec d'autres dispositifs électroniques environnants. Cet appareil produit et utilise des fréquences radio. S'il n'est pas installé et utilisé selon les instructions contenues dans le mode d'emploi, il peut générer des interférences. L'observation des normes FCC ne garantit pas qu'il y aura aucune interférence. Si cet appareil est la cause d'interférences avec une réception Radio ou TV, il est possible de le vérifier en éteignant puis en allumant l'instrument : Vous pouvez alors résoudre le problème en suivant les procédures suivantes :

- déplacer ou orienter l'antenne de l'appareil avec lequel se manifeste l'interférence.
- déplacer cet instrument ou l'appareil avec lequel se produit l'interférence
- connecter cet instrument à une prise de courant différente afin de mettre les deux appareils sur deux circuits différents.
- consulter le revendeur ou un technicien radio/tv pour d'autres renseignements.

D'éventuelles modifications non approuvées par le constructeur peuvent annuler votre garantie de l'appareil.



Viscount International S.p.A.
Via Borgo, 68 / 70 – 47836 Mondaino (RN), ITALY
Tel: +39-0541-981700 **Fax:** +39-0541-981052
Website: www.viscountinstruments.com